



**AURORA<sup>®</sup>**

**AFX<sup>™</sup>**

**MODEL MOTORING<sup>®</sup>**

WORLD'S BEST SELLING ELECTRIC HO RACING LINE

**1973**







# AURORA<sup>®</sup>

# AFX<sup>™</sup>

## MODEL MOTORING<sup>™</sup>



*Aurora, world leader in model motoring since 1960, continues to set new standards of excellence with AFX—Aurora Factory Experimentals.*

*AFX is unmatched for speed, control and performance—right out of the package!*

*AFX precision-engineered cars run so fast they leave the others on the line.*

*AFX Electric HO Racing Sets provide unequalled control, performance and value. Plus a host of exclusive, major features: AFX Speed-Lok High Performance Track, AFX Russkit pro-style Speed Controls, AFX Safety Wall-Pak. And, the world's largest selection of track and accessories. All backed with Aurora's guarantee of quality and performance.*

*With over 65,000,000 Aurora HO electric cars manufactured since 1960—it's easy to understand why AFX Model Motoring outsells all others combined. By more than two to one!*



# AFX™ NEW FOR '73

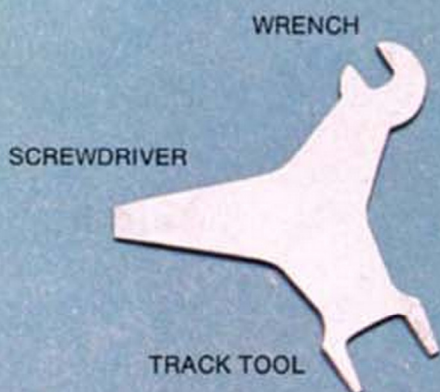

## AFX QUIKEE-LOK™

Another AFX exclusive. The new Quikee-Lok makes assembling—and taking apart—AFX Speed-Lok™ track easier than ever! Handy screwdriver and wrench makes the Quikee-Lok an indispensable HO track and car tool. Perfect for adjusting and servicing AFX cars, tracks, connections—and dozens of other uses!

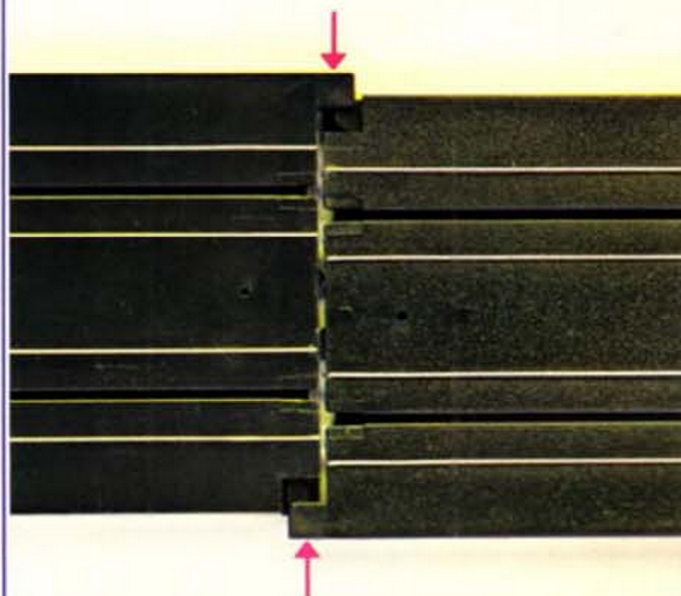

## AFX SPEED-LOK™ TRACK

So easy-to-assemble! Simply position two track sections as shown, with end tabs partially hooked. Track is now ready to snap together.

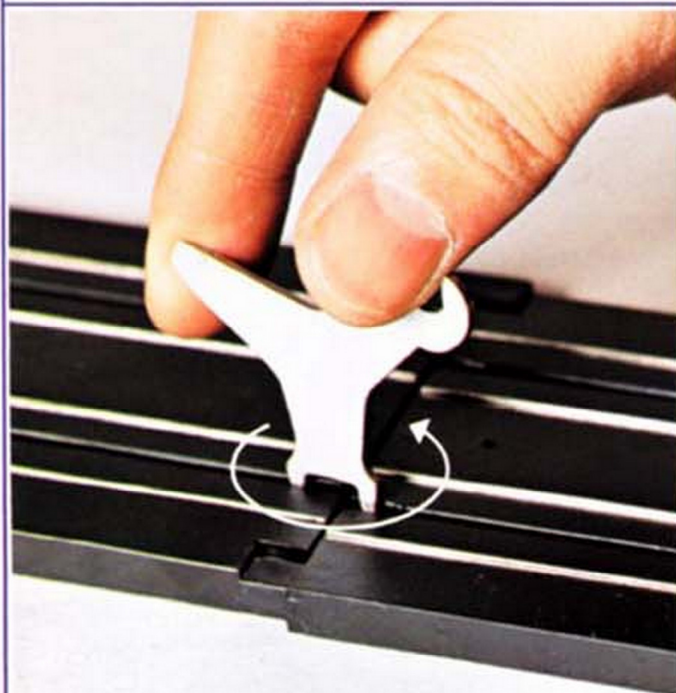

### TO ASSEMBLE

Holding the Quikee-Lok firmly, insert it straight into the track slots. Twist firmly in the direction indicated (counterclockwise) until the track snaps into place.

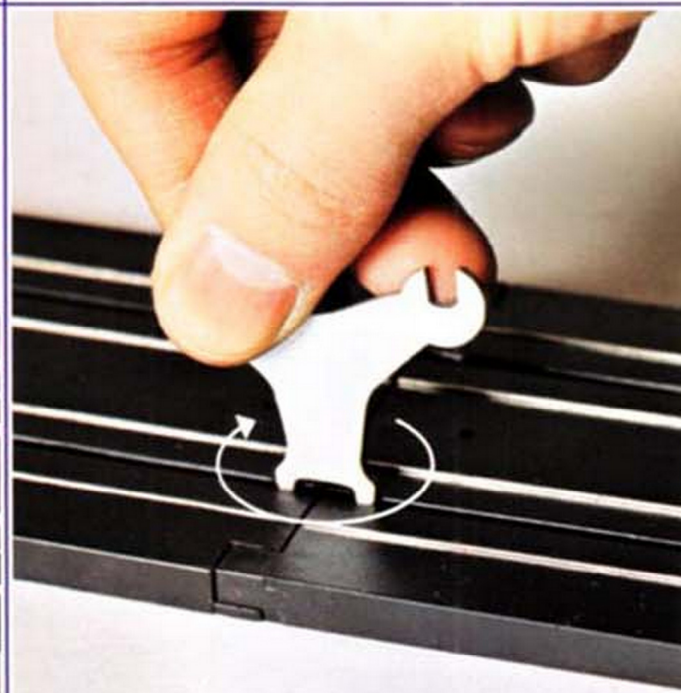

### TO OPEN TRACK

Holding track with one hand, insert the Quikee-Lok into the track slots. Twist firmly in the direction shown (clockwise) and the track will snap right open.



## AFX REVERSIBLE GUIDE PINS

Exclusive! Reversible—for every racing condition. Blade side provides an extra handling edge on AFX High Performance extra-deep-slot track. (For old style Aurora HO track, simply reverse and use the pin side).



DEEP-SLOT BLADE FOR AFX TRACK

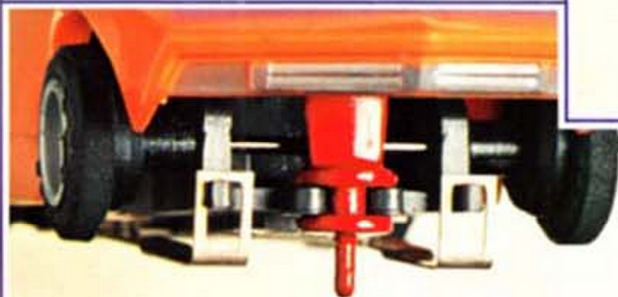

PIN FOR CONVENTIONAL HO TRACK



## SUPER-FAST AFX CARS

High-speed, easy-to-control AFX cars race like the real ones. So fast—there's nothing else in sight. Precision-engineered for unequalled high performance.

## AFX HIGH PERFORMANCE TRACK

Rugged. Easy-to-assemble. With the deepest slots in HO racing. Special "slot wedge" design at track ends eliminates guide pin snag where tracks join. Provides extra smooth and quiet high-speed racing action.

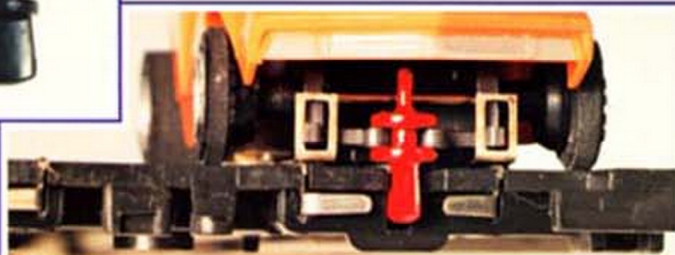

AFX HIGH PERFORMANCE TRACK WITH EXTRA-DEEP SLOTS



## AFX WALL-PAK™

Keeps the power in the wall—not on the floor. Safe, low voltage. UL listed. Comes with pre-wired clip-on terminal attached in AFX sets.



## AFX RUSSKIT SPEED CONTROLS

The full-range pro-style controller. Trigger action gives lightning fast response and positive control at all times.



2201

# AFX™ RIVERSIDE 500™

13½' OF RACING ACTION IN 3' x 4'

Multi-level racing with 2 super-fast AFX cars and over 13½ feet of AFX High Performance Track. Comes with 2 pro-style AFX Russkit Speed Controls, AFX Safety Wall-Pak, guard rails, modular bridge posts and supports, racing flags, AFX racing oil and the new Quikee-Lok.

Makes at least 3 different track layouts—the perfect "starter" set!



Retail value: \$36.33  
Track footage: 137'  
Layout size: 2'9" x 4'  
Carton pack: 4  
Weight: 15 lbs.

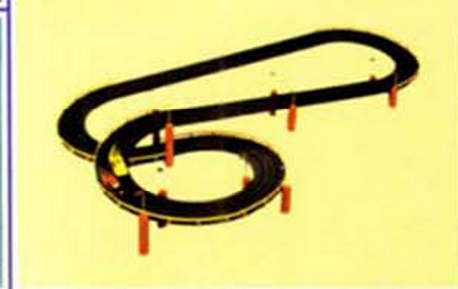
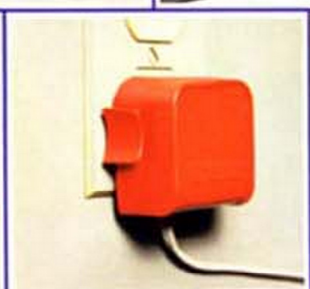
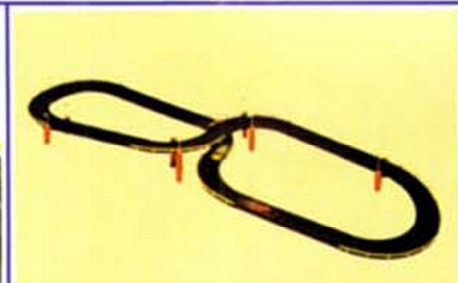



2202

# AFX™ MONTE CARLO™

18' OF 3-LEVEL RACING IN 3' x 4'

A rugged race course with high level action—18' of curves, hills and high speed straightaways! Two super-fast AFX cars, AFX High Performance Track, 2 pro-style Russkit Speed Controls, the AFX Safety Wall-Pak, guard rails, modular bridge posts, racing flags, AFX racing oil and Quikee-Lok.

Makes 3 challenging layouts—and more!

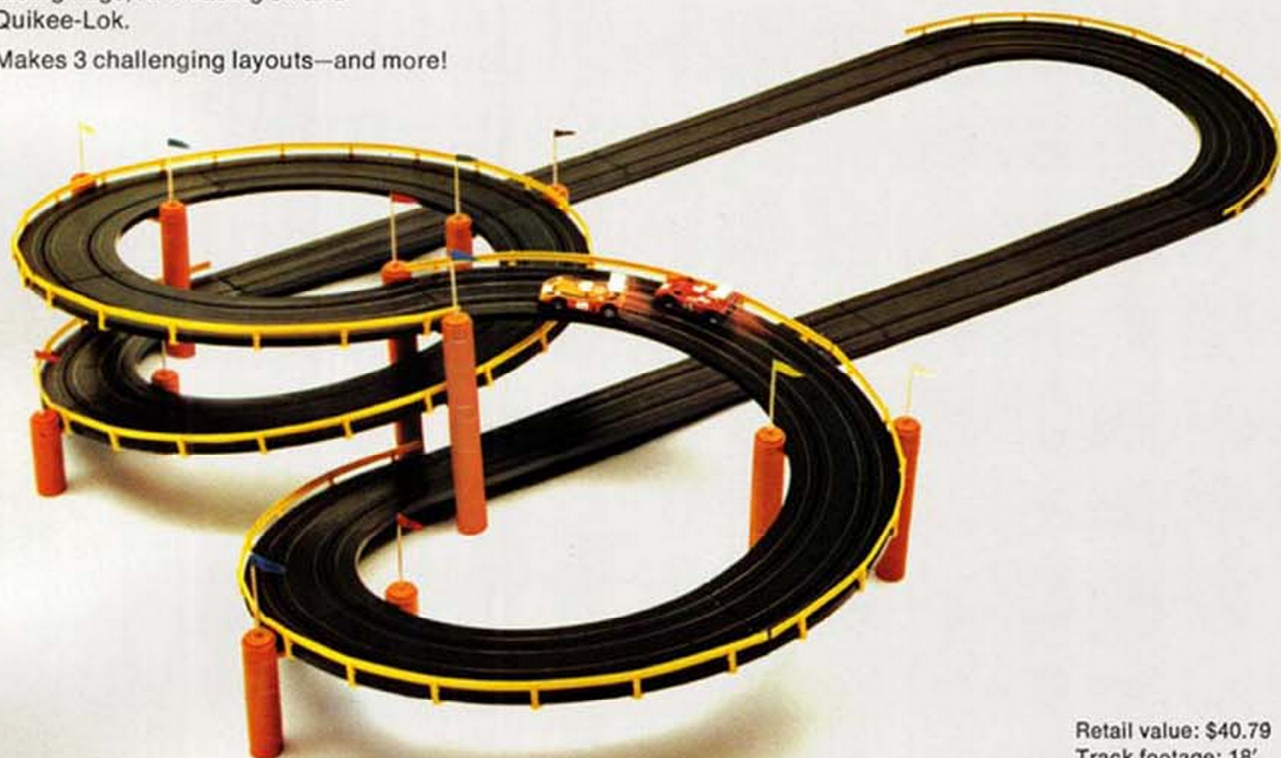

Retail value: \$40.79  
Track footage: 18'  
Layout size: 2'10" x 4'  
Carton pack: 3  
Weight: 13 lbs.

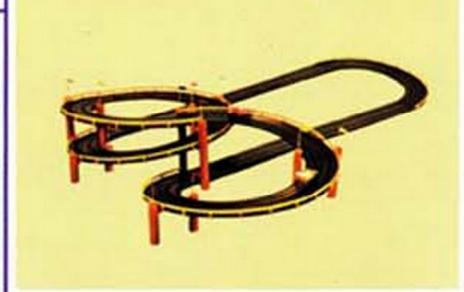
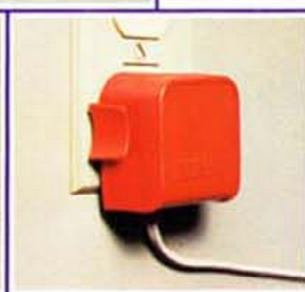
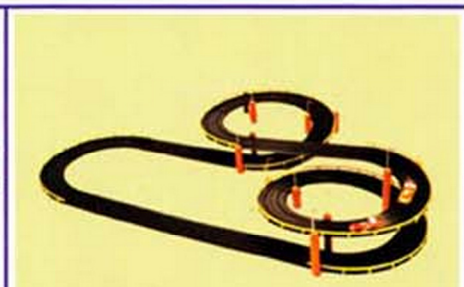



2203

## AFX™ PIT ROW SPECIAL-II™

19' OF 3-LEVEL ACTION IN 2½' x 5½'

A racing buff's delight! Challenging 3-level over-and-under racing plus the new AFX Pit Kit with high-performance parts. 19' of AFX High Performance Track with a special tight squeeze, twisting curves, grueling hills and blazing straightaways. Complete with 2 AFX racers, 2 matched Russkit Speed Controls, an AFX Safety Wall-Pak, guard rails, bridge posts, flags and Quikee-Lok.

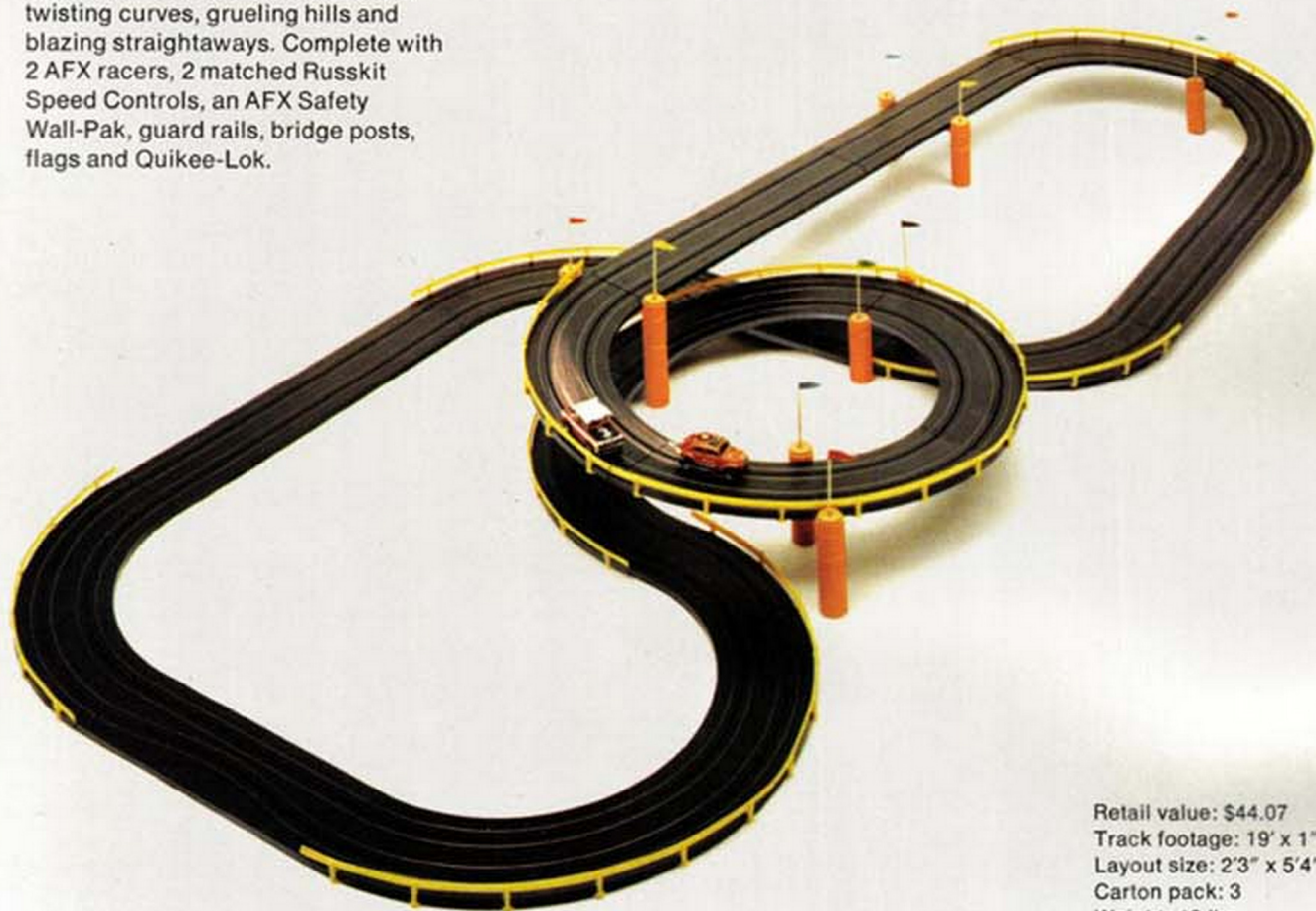

Retail value: \$44.07  
Track footage: 19' x 1"  
Layout size: 2'3" x 5'4"  
Carton pack: 3  
Weight: 13 lbs.



**NEW AFX PIT KIT**  
Slim, trim, portable. With extra AFX sponge tires, king-sized hubs, pickup shoes, brushes, racing decals and more—to really hop up AFX racers! Holds up to 7 cars, tune-up parts and a controller.

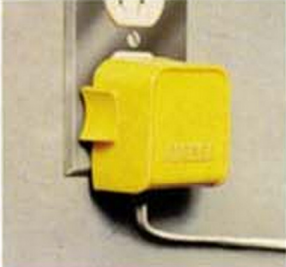



2204

# AFX™ DAYTONA 880™

24' OF 4-LEVEL RACING IN 3½' x 5½'

This high-speed, multi-level set features Aurora's exclusive 3' 4" twisting Banked "S" Curve with built-in speed walls. Passing here or anywhere on this 24' wild and winding course takes nerves of steel! Comes with 2 high performance AFX cars, 2 AFX Russkit trigger action speed controllers, the AFX Safety Wall-Pak and AFX High Performance Track. Plus track accessories, AFX racing oil and Quikee-Lok.



Retail value: \$51.85  
Track footage: 24'  
Layout size: 3'4" x 5'3"  
Carton pack: 3  
Weight: 15 lbs.

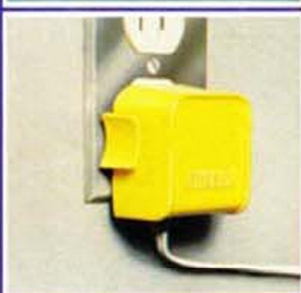
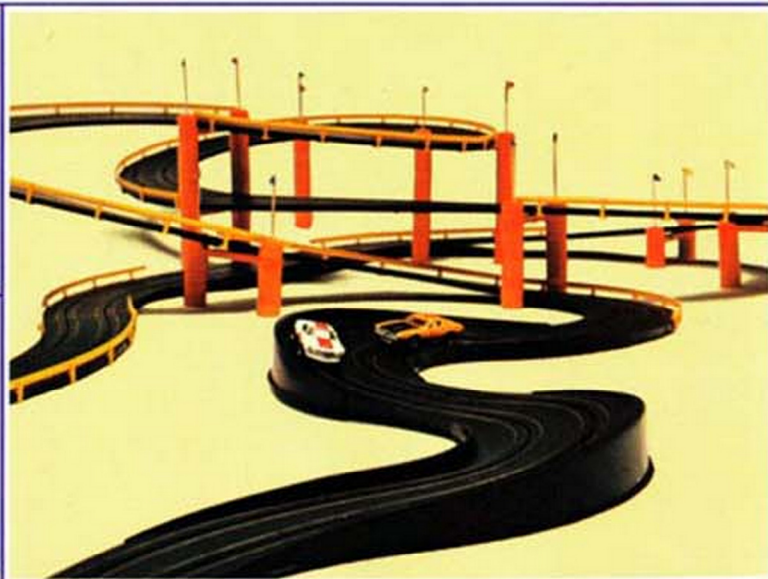



2205

# AFX™ NATIONAL SPEEDSTERS™

DOUBLE THE ACTION—SPEEDWAY AND DRAGSTRIP RACING!

There's more here than meets the eye. Looks like a great 25' racing set. But look again. The 2 AFX cars convert into demon dragsters and the straight track sets up into a 10½' dragstrip!

Comes with 2 AFX speedsters, 2 AFX Dragster body shells, front extensions and wheels. Plus 2 AFX Russkit Speed Controls, AFX High Performance Track, track and dragster accessories—including decals.



A mild-mannered Model 'A' and an elegant old Rolls turn into track-eating demon dragsters! Just remove the bodies and attach the AFX Dragster shells, front end extensions and wheels. And, with 10½' of straight track, Xmas Tree and Automatic Finish Marker and 2 AFX Russkit Speed Controls—get set for some real dragstrip racing!

Retail value: \$52.85  
Track footage: 25'2"  
Layout size: 3'6" x 7'  
Carton pack: 3  
Weight: 15 bs.





2206

# AFX<sup>TM</sup> MONZA MARATHON<sup>TM</sup>

32' OF ALL-OUT RACING ACTION IN 4' x 7½'

The action never stops on this spine-tingling 32' marathon endurance course. A thrilling challenge—with exclusive AFX 2' 4" high-banked Hairpin Curve and 5' of twisting Banked "S" Curves. Plus the classic 2½' Monza Curve! And—2 high speed AFX cars, 2 AFX Russkit Speed Controls, AFX High Performance Track, AFX Safety Wall-Pak, modular bridge posts, guard rails, racing flags, AFX racing oil and Quikee-Lok.



Retail value: \$68.29  
Track footage: 32'2"  
Layout size: 4' x 7'4"  
Carton pack: 3  
Weight: 16 lbs.





2207

# AFX™ FIRECRACKER 4+4

4 LANE SPLIT-TRACK SPEEDWAY RACING

Four on the floor competition. Four super-swift AFX speedsters plus a four lane speedway multiplies the action and excitement! Side by side racing suddenly splits off into two directions. Special AFX UL listed High Performance Power Pack—with on-off switch—is engineered for peak performance with 4 AFX racers and 4 AFX Russkit Speed Controls. Set includes 2 AFX Clip-On Terminals, 27' of AFX High Performance Track which can also be used as a 2 lane course. Plus 6" wide modular bridge supports, posts, flags, racing oil and Quikee-Lok.



Retail value: \$63.82  
Track footage: 27'  
Layout size: 4' x 4'8"  
Carton pack: 3  
Weight: 17 lbs.

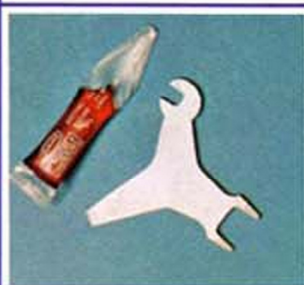



# AFX™ NEW FOR '73



1787:400  
AFX MATADOR STOCK CAR



1786:400  
AFX PORSCHE 510K "CAN-AM"



1778:400  
AFX "BAJA BUG" VW



1777:400  
AFX '55 CHEVY BEL AIR



1776:400  
AFX BRE-DATSUN 510 "TRANS-AM"



1775:400  
AFX BRE-DATSUN 240Z

All AFX cars packed 24 per carton. Weight: 9 lbs.



# AFX™ NEW FOR '73



1791:400  
'31 MODEL 'A' FORD PANEL



1781:400  
ROARIN' ROLLS "GOLDEN GHOST"

### 3 FOR '73

This exciting new trio—'31 Model 'A', Roarin' Rolls and the Peace Tank—comes with a specially modified AFX chassis, AFX super-size sponge rear tires plus a host of AFX high performance features.

### 4 NEW AFX DRAGSTERS

Introducing the first AFX HO Dragsters—designed to drag race on straight AFX High Performance Track. Features the specially modified AFX chassis with dragster front end extension, AFX super-wide, super-size sponge rear tires plus AFX speed, performance and quality.

**EXTRA BONUS!** Every AFX Dragster comes with its own racing decals—and can be decorated as pictured.



1782:400  
PEACE TANK



1774  
"FURIOUS FUELER"

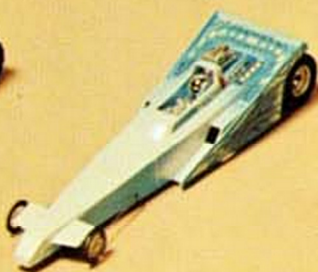

1794  
"DYNO-MITE"



1772  
"DODGE FEVER"



1792  
"AZTEC"



# AFX™ ELECTRIC HO RACING CARS



1773:400  
AFX DODGE CHARGER STOCK CAR



1769:400  
AFX FORD "BAJA BRONCO"



1768:400  
AFX SHADOW "CAN-AM"



1767:400  
AFX LOLA T-260

## AFX "FLAMETHROWER"™ CARS WITH HEADLIGHTS

All the speed, control and high performance of AFX racers—  
plus operating headlights for racing in the dark!



1798:400  
AFX "FLAMETHROWER" PORSCHE 917



1799:400  
AFX "FLAMETHROWER" FERRARI 512M

All AFX cars packed 24 per carton. Weight: 9 lbs.





1766:400  
AFX CORVETTE FUNNY CAR



1765:400  
AFX JAVELIN PRO STOCKER



1764:400  
AFX JAVELIN AMX "TRANS-AM"



1763:400  
AFX FERRARI 512M



1762:400  
AFX PLYMOUTH ROAD RUNNER



1761:400  
AFX PINTO FUNNY CAR



1760:400  
AFX '57 CHEVY NOMAD



1759:400  
AFX VEGA VAN "GASSER"





1758:400  
AFX PLYMOUTH 'CUDA FUNNY CAR



1757:400  
AFX PORSCHE 917



1756:400  
AFX CAMARO Z-28 "TRANS-AM"



1755:400  
AFX "TURBO TURNON"



1754:400  
AFX "TOO MUCH"



1753:400  
AFX DODGE CHARGER DAYTONA



1752:400  
AFX AUTO WORLD XLR McCLAREN



1751:400  
AFX FERRARI 612 "CAN-AM"



# AFX™ NEW FOR '73

AFX sets new standards for styling, design and performance in HO model motoring.

Unmatched realism and authentic body detailing. A fantastic lineup of International, Can-Am, and Trans-Am racing champions. Plus top stock cars, drag racers and classic street machines.

Breathtaking speed. Unbelievable control. High-performance cars that can't be touched by anything in sight.

All with the exclusive AFX self-lubricating Nylatron chassis and a low, road-hugging center of gravity. Plus AFX super-fat sponge race tires, spring-balanced pickup shoes and a deep slot guide pin that makes for faster-than-ever cornering, better control and handling—lap after lap.

Now in a dramatic new "showcase" package for '73!

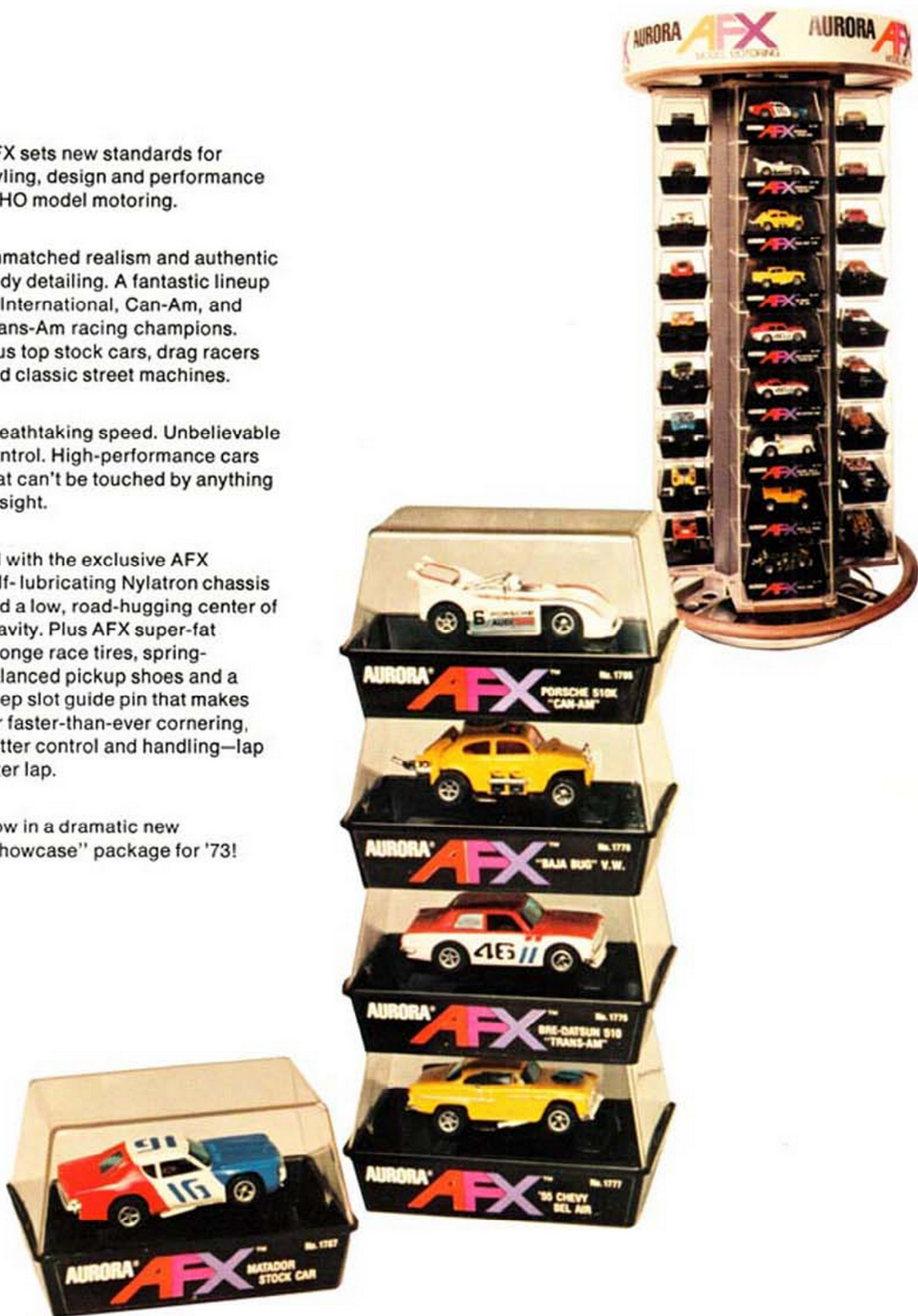



# AFX™ SUPER II

**AFX SUPER II**  
**NEW...IMPROVED FOR '73**

## *Super-star performance— Now in 4 super racing colors*

A/FX Super II is the first production HO model racer that is precision-engineered for record breaking performance—right out of the box!

A/FX Super II runs up to 35% faster than a stock A/FX car operated at the same voltage. Speed-timed and track-tested at over 2,000 scale mph.

A/FX Super II is assembled and factory-tested with the meticulous care of a limited edition custom-made racer—yet is priced within reach of the discriminating model motoring fan.



- ① SUPER-LITE VAC-FORMED BODY
- ② INTEGRATED NOSE WEIGHT AND BODY MOUNT
- ③ FULLY ARTICULATED SIDE WEIGHTS
- ④ LIGHTWEIGHT PICKUP SHOES\*
- ⑤ MACHINED ALUMINUM FRONT WHEELS
- ⑥ LOW-FRICTION O-RING TIRES
- ⑦ MACHINED ALUMINUM RACING WHEELS
- ⑧ SUPER-SOFT SPONGE TIRES
- ⑨ DOUBLE-WOUND QUADRA-LAM ARMATURE
- ⑩ 19 TOOTH SUPER-MESH CROWN GEAR
- ⑪ SUPER-COOL COMMUTATOR BRUSH TUBE ASSEMBLY
- ⑫ SUPER MAGNETS

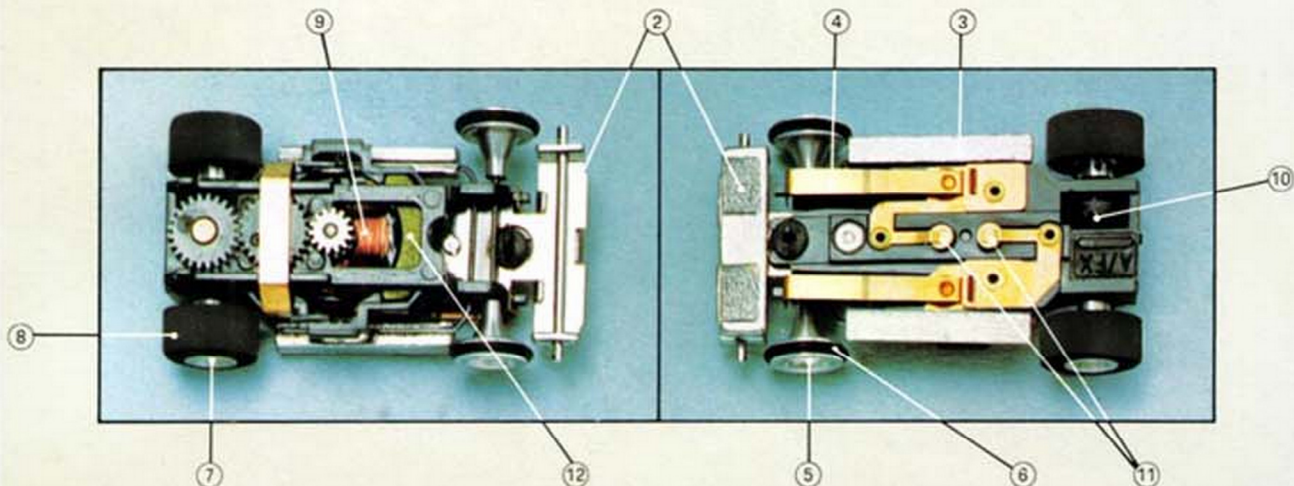

\*Braided pickup shoes for competition racing are included.





**2544**  
**AFX BANKED HAIRPIN CURVE**  
 The tightest HO racing curve! Built-in speed walls and AFX extra-deep slots for high speed turns on this unique 6" radius banked curve.  
 Carton pack 12. Weight 14 lbs.

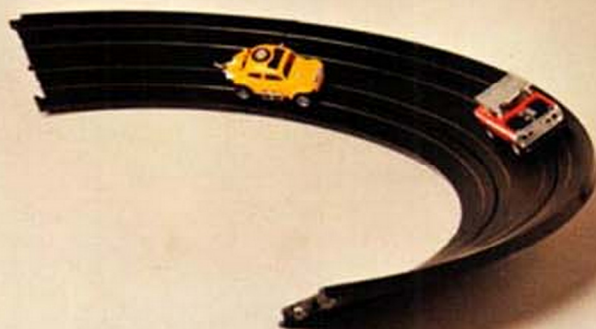

**2467**  
**AFX MONZA BANKED CURVE SET**  
 A four piece 9" radius banked curve set—with AFX extra-deep racing slots. Use alone or set up inside the Daytona Banked Curve.  
 Carton pack 12. Weight 7 lbs.



**2545**  
**AFX DAYTONA BANKED CURVE SET**  
 Two high speed 12" radius banked curves with built-in guard rails and AFX extra-deep racing slots. Track supports included.  
 Carton pack 12. Weight 13 lbs.



**2543**  
**AFX BANKED "S" CURVE SET**  
 This exclusive pair of banked "S" curves combines to make 3'4" of exciting, high speed racing action. Modular design permits maximum layout flexibility—used singly, in pairs, or fours. Built-in guard rails and AFX extra-deep racing slots.  
 Carton pack 12. Weight 18 lbs.



# AFX™ TRACK AND ACCESSORIES

AFX Model Motoring is a completely modular system that grows... and grows... and grows! AFX sets can be expanded to make hundreds of different and exciting layouts—simply by adding AFX track, cars and racing accessories.

## 2501: 9" WIGGLE

Carton pack 48. Weight 7 lbs.

## 2502: 9" DOUBLE CROSS (PAIR)

Carton pack 48 pairs. Weight 8 lbs.

## 2503: 9" "Y" TRACK (PAIR)

Carton pack 48 pairs. Weight 19 lbs.

## 2506: 9" COBBLESTONE TRACK AND SIGN

Carton pack 48. Weight 7 lbs.

## 2513: 9" RADIUS CRISSCROSS (PAIR)

Carton pack 48 pairs. Weight 25 lbs.

## 2521: 9" JUNCTION TURNOFF (PAIR)

Carton pack 12 pairs. Weight 7 lbs.

## 2523: 90° INTERSECTION

Carton pack 24. Weight 12 lbs.

## 2524: 9" CRISSCROSS (PAIR)

Carton pack 48 pairs. Weight 18 lbs.

## 2539: 9" SQUEEZE

Carton pack 48. Weight 7 lbs.

## 2551: 9" ADAPTER TRACK (PAIR)

Carton pack 48 pairs. Weight 17 lbs.

**NOTE: No. 2551 Adapter Track is used to join old style Aurora HO track together with the new AFX Speed-Lok track.**



2539: 9" SQUEEZE



2502: 9" DOUBLE CROSS (PAIR)



2501: 9" WIGGLE



2524: 9" CRISSCROSS (PAIR)



2503: 9" "Y" TRACK (PAIR)



2551: 9" ADAPTER TRACK (PAIR)



2506: 9" COBBLESTONE TRACK AND SIGN



2513: 9" RADIUS CRISSCROSS (PAIR)



2521: 9" JUNCTION TURNOFF (PAIR)

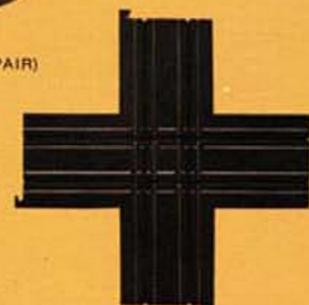

2523: 90° INTERSECTION

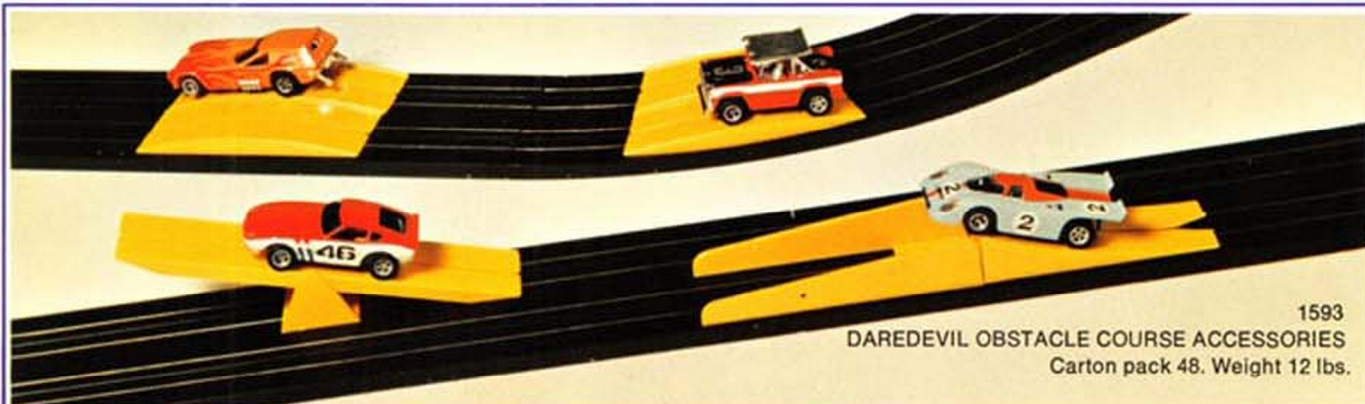

1593  
DAREDEVIL OBSTACLE COURSE ACCESSORIES  
Carton pack 48. Weight 12 lbs.



# AFX™ TRACK AND ACCESSORIES

## AFX SPEED-LOK™ HIGH PERFORMANCE TRACK

### CURVED TRACK

2514: 9" RADIUS (1/8 circle)  
Carton pack 48. Weight 5 lbs.

2518: 6" RADIUS (1/4 circle)  
Carton pack 48. Weight 6 lbs.

2519: 9" RADIUS (1/4 circle)  
Carton pack 48. Weight 10 lbs.

2528: 12" RADIUS (1/8 circle)  
Carton pack 48. Weight 7 lbs.

2533: 15" RADIUS (1/8 circle)  
Carton pack 48. Weight 9 lbs.

2540: 6" RADIUS (1/8 circle)  
Carton pack 48. Weight 3 lbs.

### STRAIGHT TRACK

2515: 5" STRAIGHT  
Carton pack 48. Weight 4 lbs.

2516: 7" STRAIGHT  
Carton pack 48. Weight 6 lbs.

2517: 9" STRAIGHT  
Carton pack 48. Weight 8 lbs.

2526: 9" LAP COUNTER (Not shown)  
Carton pack 48. Weight 10 lbs.

2527: 6" STRAIGHT  
Carton pack 48. Weight 5 lbs.

2542: 15" STRAIGHT  
Carton pack 48. Weight 12 lbs.

2546: 15" STRAIGHT (4 PC. PACK)  
Carton pack 12 4-pc. packs. Weight 14 lbs.



2542: 15" STRAIGHT



2517: 9" STRAIGHT



2516: 7" STRAIGHT



2515: 5" STRAIGHT

1/8 CIRCLE



2540: 6" RADIUS



2514: 9" RADIUS



2528: 12" RADIUS



2533: 15" RADIUS

1/4 CIRCLE



2518: 6" RADIUS



2519: 9" RADIUS



2504  
LOOP-THE-LOOP  
(PAIR—WITH TRACK)  
Carton pack 12. Weight 15 lbs.



1594  
SPIRAL TRACK SUPPORT  
Carton pack 48. Weight 19 lbs.



# AFX RACING ACCESSORIES



NEW

1469  
AFX PIT KIT CARRYING CASE  
Carton pack 24. Weight 18 lbs.

1488  
AFX PIT KIT CARRYING CASE WITH  
AFX HIGH PERFORMANCE PARTS KIT  
Carton pack 24. Weight 24 lbs.

NEW



2555  
AFX DRAGSTER XMAS TREE  
AND AUTOMATIC FINISH LINE MARKERS  
Carton pack 24. Weight 9 lbs.



NEW

1489  
AFX RACE CASE WITH TRAY  
Carton pack 24. Weight 24 lbs.



1343  
AFX AURORA-RUSSKIT  
45 OHM SPEED CONTROL  
Carton pack 24. Weight 6 lbs.



1454  
AFX AURORA-RUSSKIT  
45 OHM SPEED CONTROL WITH  
BRAKES  
Carton pack 24. Weight 7 lbs.



1342  
AFX SAFETY WALL-PAK™ WITH  
CLIP-ON TERMINAL. UL LISTED  
Carton pack 6. Weight 5 lbs.

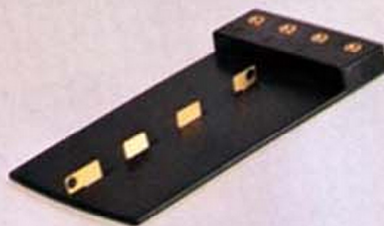

1555  
AFX CLIP-ON ANYWHERE TERMINAL  
Carton pack 48. Weight 2 lbs.



1349  
AFX DC-2 HIGH PERFORMANCE  
POWER PACK WITH ON-OFF SWITCH.  
UL LISTED  
Carton pack 6. Weight 9 lbs.



# AFX™ RACING ACCESSORIES

Three AFX high performance diagnostic units—professional test equipment for HO racing buffs! Use them individually, or as a test center.

1544

AFX "SPEED SHIFTER POWER CONTROL"  
Carton pack 12. Weight 9 lbs.

1545

AFX "WEIGHT ANALYZER"  
Carton pack 12. Weight 9 lbs.

1547

AFX "DYNO TACH"  
Carton pack 12. Weight 10 lbs.



1545

1544

1547

1461

AFX HIGH PERFORMANCE PARTS KIT  
Carton pack 48. Weight 6 lbs.



1450



1451



1453



1452



1456

1450: START-FINISH PYLONS  
Carton pack 36. Weight 7 lbs.

1451: JUDGE'S STAND  
Carton pack 36. Weight 9 lbs.

1452: GRANDSTAND  
Carton pack 36. Weight 24 lbs.

1453: DUAL PIT STOP  
Carton pack 36. Weight 21 lbs.

1456: CURVED BLEACHERS  
Carton pack 36. Weight 15 lbs.

#### ADDITIONAL AFX RACING ACCESSORIES

1345: AURORA-RUSSKIT  
80 OHM SPEED CONTROL (FOR T-JET CARS)  
Carton pack 24. Weight 6 lbs.

1347: T-JET RACING SPEED CONTROL  
Carton pack 24. Weight 4 lbs.

1529: TRESTLE EXTENSIONS (SET OF 12)  
Carton pack 36. Weight 4 lbs.

1530: TRESTLE POST ASSORTMENT  
Carton pack 72. Weight 2 lbs.

1531: 2 LANE TRACK JOINERS  
AND LOCK SET (24 JOINERS, 12 LOCKS)  
Carton pack 72. Weight 5 lbs.

1532: GUARD RAILS (SET OF 8)  
Carton pack 48 sets. Weight 12 lbs.

1591: MODULAR BRIDGE POSTS (24)  
Carton pack 48. Weight 17 lbs.

1592: MODULAR BRIDGE BEAM SET  
(4-3" Beams, 24 Posts)  
Carton pack 48. Weight 15 lbs.

1599: MODULAR BRIDGE BEAMS (6" WIDE—SET OF 4)  
Carton pack 48. Weight 7 lbs.

1590: AFX QUIKEE-LOK™ TRACK AND CAR TOOL  
Carton pack 48. Weight 5 lbs.



OUTSELLS ALL OTHERS COMBINED. BY MORE THAN TWO TO ONE!

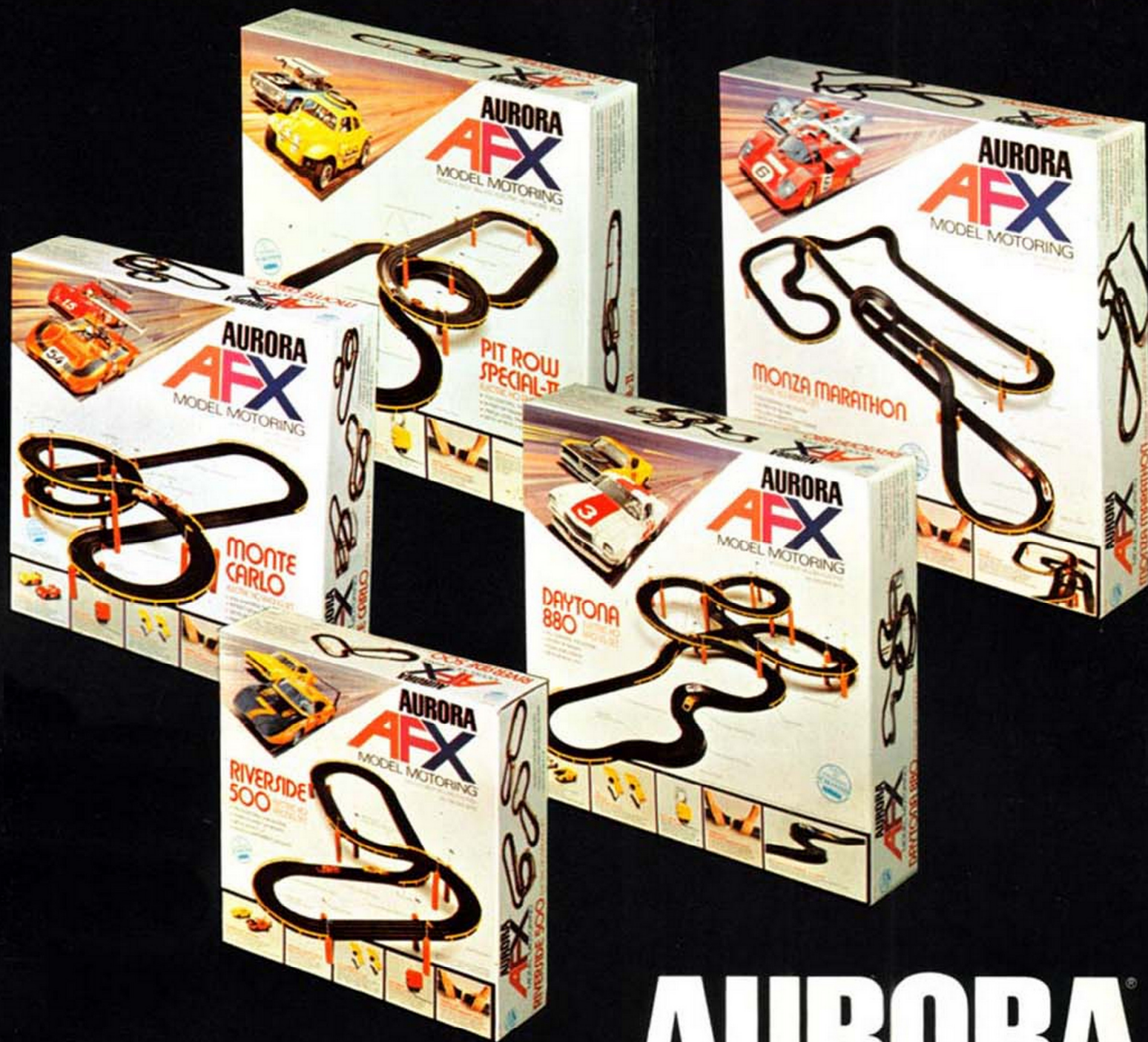

# AURORA®

# AFX™

# MODEL MOTORING®

