

# HO RAILROAD and MODEL MOTORING ACCESSORIES

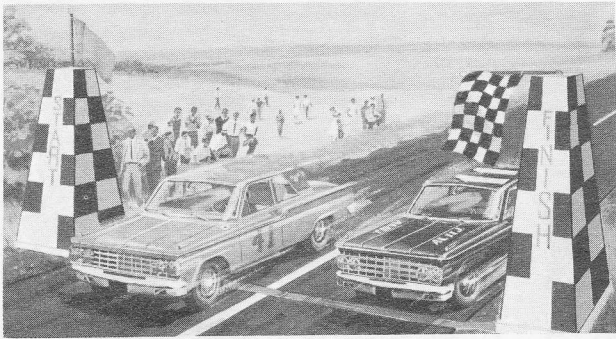

**KIT NO. 1450**  
**START/FINISH PYLONS** ..... **.98**

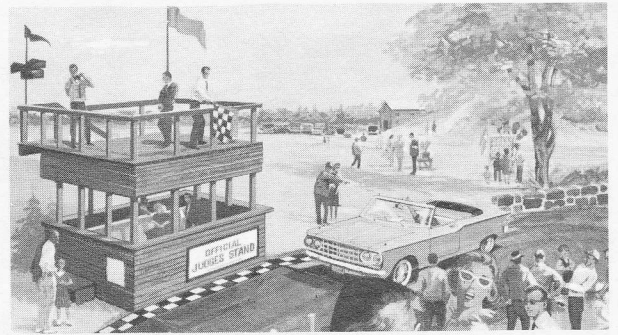

**KIT NO. 1451**  
**JUDGES' STAND** ..... **.98**

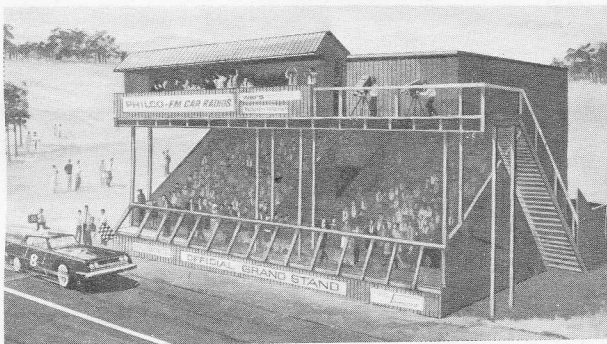

**KIT NO. 1452**  
**GRAND STAND** ..... **1.98**

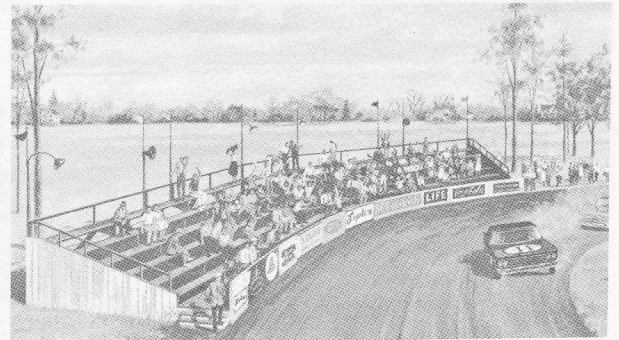

**KIT NO. 1456**  
**CURVED BLEACHERS** ..... **1.49**

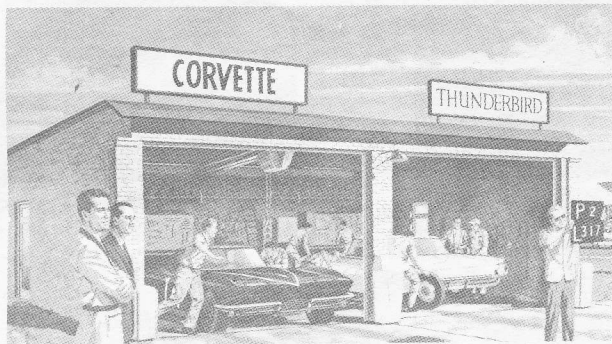

**KIT NO. 1453**  
**DUAL PIT STOP** ..... **1.98**



**KIT NO. 1449**  
**"PIT KIT" CARRYING CASE** ..... **1.49**

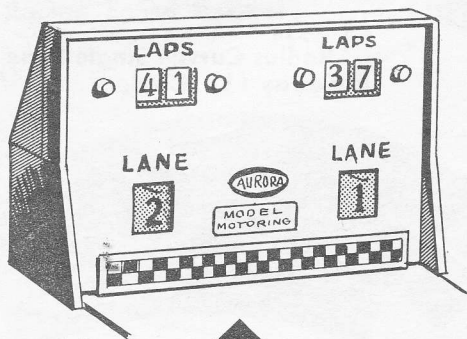

**No. 1465**  
**2 Lane Remote Elect.**  
**Lap Counter with 9"**  
**Trip Track Sec.** ..... **9.95**

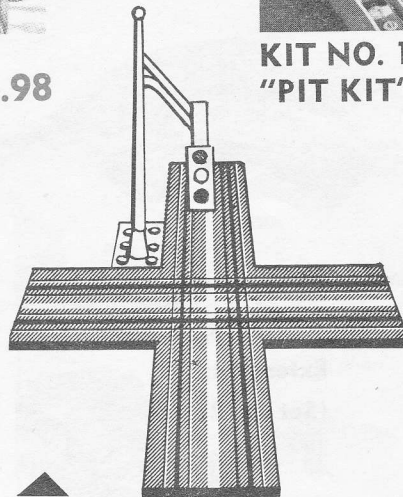

**No. 1466**  
**Auto. 4-Way Traffic Light**  
**with Timer & 90° Intersection** ..... **14.95**



**No. 1462**  
**Hop Up Kit** ..... **.98**

# CARS and TRUCKS

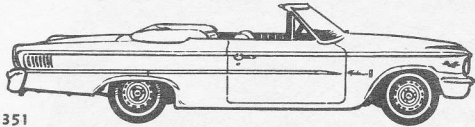

No. 1351  
'63 1/2 Ford Galaxie 500/XL Convertible ..... 2.98

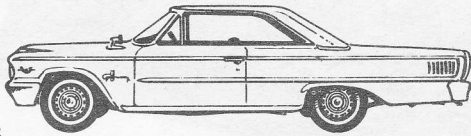

No. 1352  
'63 1/2 Ford Galaxie 500/XL Hard Top ..... 2.98

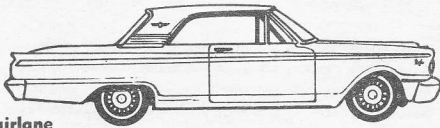

No. 1353  
'63 Ford Fairlane Hard Top ..... 2.98

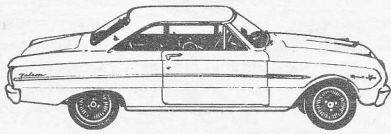

No. 1354  
'63 1/2 Ford Falcon Sprint Hard Top ..... 2.98

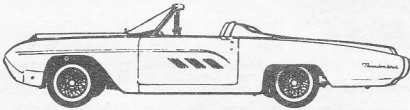

No. 1355  
'63 Thunderbird Sports Roadster ..... 2.98

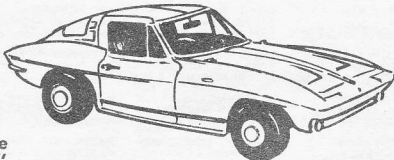

No. 1356  
'63 Corvette "Sting Ray" ..... 2.98

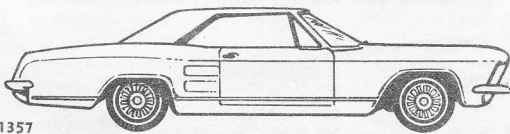

No. 1357  
'63 Buick "Riviera" ..... 2.98

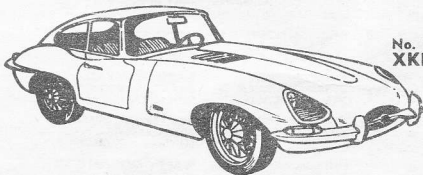

No. 1358  
XKE Jag ..... 2.98



No. 1359  
Indianapolis Racer ..... 2.98

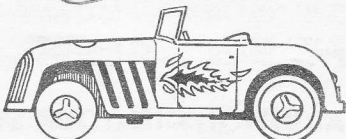

No. 1365  
"Hot Rod" Roadster ..... 2.98

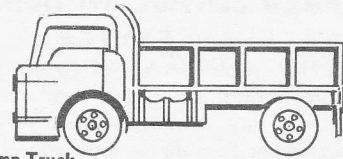

No. 1362  
Mack Dump Truck ..... 3.49

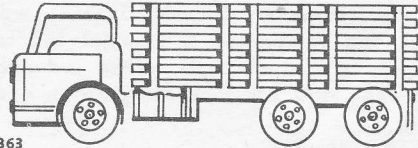

No. 1363  
Mack Stake Truck ..... 3.49

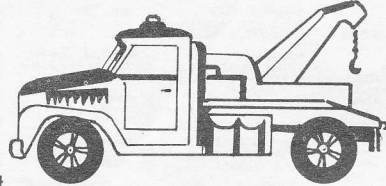

No. 1364  
International Wrecker (Tow Truck) ..... 3.49

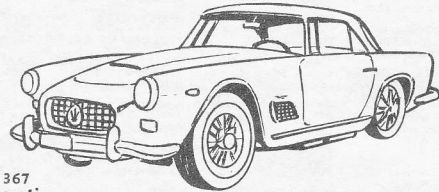

No. 1367  
Maserati ..... 2.98



No. 1368  
Ferrari ..... 2.98

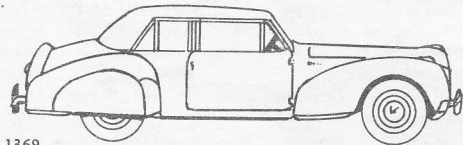

No. 1369  
Classic Lincoln Continental ..... 2.98

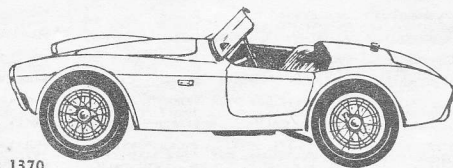

No. 1370  
A C Cobra ..... 2.98

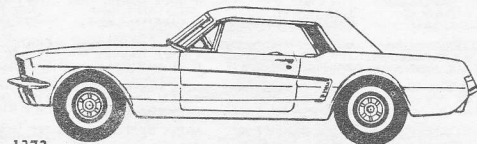

No. 1372  
Ford "Mustang" ..... 2.98



No. 1366  
"Hot Rod" Coupe ..... 2.98

# Model Motoring AUTHORIZED SERVICE STATIONS

## PARTS & SERVICE

Spare Parts for replacement of worn parts resulting from normal wear and tear may be purchased from any Authorized Service Station or direct from Factory — Authorized Service Stations are not obligated to replace or repair any defective part — this is a Factory guarantee. However, Service Stations will make needed repairs at a nominal service charge — plus cost of parts. When ordering parts by mail add 25c to cover postage and handling.



<b>ALABAMA</b> YOST CARD & TOY CULLMAN, ALABAMA WESTERN AUTO 203 MAIN ST. ALEX CITY, ALA.  WESTERN AUTO 211 N. COURT ST. FLORENCE, ALA.  HOMEWOOD CYC & HBY 2735 S. 15th ST. HOMEWOOD 9, ALA. CATHAS TOY & HBY 127 WASHINGTON ST. HUNTSVILLE, ALA. HUNTSVILLE HOBBY 2100 TRIANA BL SW HUNTSVILLE, ALA. PAUL BROWNS TOY 1314 SPRINGDALE MOBILE, ALA. SRING HILL HDWE 4415 OLD SHELL RD. HILL, ALA.  TOYTOWN EASTBROOK SHP CTR MONTGOMERY, ALA. ALASKA HOBBY LOBBY 339 FOURTH ST. ANCHORAGE, ALASKA HOBBY HOUSE 419 SECOND ST. FAIRBANKS, ALASKA SPENARD HOBBY BOX 128 SPENARD, ALASKA ARIZONA CHANDLER HBY SHOP 78 W. BOSTON ST. CHANDLER, ARIZ. HOBBY HAVEN 10 N. LEROU FLAGSTAFF, ARIZ. FINNEGINS HOBBY SHO 323 BEALE ST. KINGMAN, ARIZ. WEBSTER HOBBY HSE 132 W. MAIN ST. MESA, ARIZ. FREDS CRAFTS HOBBIES 3211 E. CAMELBACK PHOENIX, ARIZ. GORDON'S HOBBY LBY 35th & BETHANY PHOENIX, ARIZ. HAPPINESS HOUSE 8040 N. 27th AVE. PHOENIX 21, ARIZ. HAPS HOBBY SHOP 3336 N. 19th AVE. PHOENIX, ARIZ. THE HBY CTR 2420 E. THOMAS RD. PHOENIX, ARIZ. HOBBY DEN 6012 N. 27th AVE. PHOENIX, ARIZ. HOBBY HAVEN 1618 E. THOMAS PHOENIX, ARIZ. MC D HOBBY SHOP 5617 S. CENTRAL AVE. PHOENIX, ARIZ. TOY FAIR 5043 W. IND. SCH RD PHOENIX 31, ARIZ. WAGON WHEEL SHOP 4888 E. THOMAS RD. PHOENIX, ARIZ. WEBSTER HOBBY SHOP 521 E. CAMELBACK PHOENIX, ARIZ. PALS TOYS 115 PARK CENTRAL PHOENIX, ARIZ.	ORIGINALITIES 415 S. MONTEZUMA PRESCOTT, ARIZ. MAYMANS 7107 E. McDOWELL SCOTTSDALE, ARIZ. THE TOY SHOPS 55 W. CONGRESS TUCSON, ARIZ. TOWNSENDS HOBBY 2751 N. CAMPBELL TUCSON, ARIZ. TOY SHOP 3368 S. 6th ST. TUCSON, ARIZ. TUCSON TRAIN HOB 4552 E. SPEEDWAY TUCSON, ARIZ. WARES TOY SHOP 3368 S. 6th AVE. TUCSON, ARIZ. WOODYS TOYTOWN 6176 E. SPEEDWAY TUCSON, ARIZ. WOODYS TOWN TOWNS 3907 E. GRANIT TUCSON, ARIZ. KENS HOBBY SHOP 1828 8th AVE. YUMA, ARIZ. ARKANSAS HOFFS HOBBIES 208 N. CLEVELAND EL DORADO, ARK. FRANS MODEL TRAIN 3620 N 46th ST. FT. SMITH, ARK. HOBBY & ART HOUSE VILLAGE SHG CTR. LITTLE ROCK, ARK. HOBBYLAND 2813 KAVANAUGH LITTLE ROCK, ARK. LIT JOES HOBBY SHOP 5819 KAVANAUGH LITTLE ROCK, ARK. JONES, INC. 72 WESTMINSTER DR. LITTLE ROCK, ARK. CALIFORNIA ALAMEDA HOBBYCRAFT 1356 PARK ST. ALAMEDA, CALIF. ALAMEDA PAINT 1523 WEBSTER ST. ALAMEDA, CALIF. HARLEYS HSE HOBBYS 2417 W. HELLMAN AVE. ALHAMBRA, CALIF. PALACE SPORT DS. 51 G. ST. ANTIOCH, CALIF. AUBURN HOBBY SHOP 1124 HIGH ST. AUBURN, CALIF. PIRATES TREASURE 5221 CLYDEBANK AVE. AZUSA, CALIF. STEWARTS HOBBY 900 21st ST. BAKERSFIELD, CALIF. TOY CIRCUS 1228 19th ST. BAKERSFIELD, CALIF. WOODYS TOY CIRCUS 19th & L STREETS BAKERSFIELD, CALIF. CARRS DEPT. STORE 410 N. MAIN AVE. BALDWIN PK, CALIF. EARLS HOBBY CTR 17439 S. BELLFLOWER BELLFLOWER, CALIF. CARLMOOT HOBBY 2033 RALSTON AVE. BELMONT, CALIF. BERKELEY HARDWARE 2109 UNIVERSITY AVE. BERKELEY, CALIF.	BIRDIES TOY 82 SHATTUCK SQ. BERKELEY, CALIF. MINIATURE TRAIN KNOTTS BERRY FARM BUENA PARK, CALIF. BEANIES HOBBY 850 N. HOLLYWOOD BURBANK, CALIF. BURBANK HSE HBYS 923 W. OLIVE AVE. BURBANK, CALIF. T & A HOBBY LOBBY 3518 W. VICTORY BURBANK, CALIF. HOBBY SHOP 1208 BURLINGAME BURLINGAME, CALIF. HOBBYVILLE 1855 EL CARMINE BURLINGAME, CALIF. MILLER HUNGER TOY 220 PRIMROSE RD. BURLINGAME, CALIF. SUNSHINE CARD 349 N. WINCHESTER CAMPBELL, CALIF. HOBBY CORRAL 6452 FAIR OAKS BLVD CARMICHAEL, CALIF. SCOTTS CAMERA 4571 GLENMOOR CENTERVILLE, CALIF. CHICO HBY & TOY 526 BROADWAY CHICO, CALIF. WRIGHTS TOY TR 177 E. 2nd CHICO, CALIF. H. J. HEINZ 1042 KASKI LANE CONCORD, CALIF. GARDEN GROVE SHOP 8751 GRDN GROVE GARDEN GROVE, CALIF. AUTO HOBBIES 3045 OCEAN VIEW GLENDALE, CALIF. VANCO HOBBY 138 S. BRAND BLVD. GLENDALE, CALIF. ROCKS TOY STORE 146 N. MICHIGAN GLENDORA, CALIF. WRIGHTS HOBBIES 5733 HOLLISTER AVE. GOLETA, CALIF. GRANADA HILLS HBY 17812 CHATSWORTH GRANADA HILLS, CALIF. VALLEY TOY TOWN 10156 N. BALLBADA GRANADA HILLS, CALIF. MOES TOY SHOP 301 N. DOUTY ST. HANFORD, CALIF. BIRDIES TOY HSE 22483 FOOTHILL HAYWARD, CALIF. JOE THE TRAIN DOCTOR 707 VINE ST. HOLLYWOOD, CALIF. REGINALD DENNY 5751 HOLLYYWD BLVD HOLLYWOOD, CALIF. HOLLYWOOD HBY 1522 CAHUENGA HOLLYWOOD 28, CALIF. OUTDOORSMAN 82 880 MILES AVE INDIO, CALIF. THE TRAINMAN 537 W. FAIRVIEW INGLEWOOD, CALIF. CRAINS TRAIN & HBY 1112 N. GLENDORA LA PUENTE, CALIF. THE TOY BIN 13907 ELLIOT LA PUENTE, CALIF. THE HOBBY HUT 980A HOUGH AVE. LAFAYETTE, CALIF. J & M GEN MDSE 10540 MAIN ST. LAMONT, CALIF. FLOYDS TOY TOWN 7923 BROADWAY LEMON GROVE, CALIF.	DILLON SPT 3750 BROADWAY EUREKA, CALIF. HENDERSON SPORT 2811 F STREET EUREKA, CALIF. SCOTTS CAM & HBY 4571 GLENMOOR MAL FREMONT, CALIF. ARTHURS TOP SHOP 3033 BLACKSTONE FRESNO 3, CALIF. DONS HOBBY 3117 MAYFAIR FRESNO, CALIF. EASTMAN HOBBY 1449 FULTON ST. FRESNO, CALIF. FRESNO HOBBY 3032 E. TULARE FRESNO, CALIF. GRAND CENTRAL TOY 1001 BROADWAY FRESNO, CALIF. HILL N DALE 108 E. OLIVE FRESNO, CALIF. TOMS TRAINS 6452 FAIR OAKS BLVD FRESNO, CALIF. HOBBY HOUSE 1659 W. ORANGETHORP FULLERTON, CALIF. THORESENS 773 REDWOOD HWY GARBERVILLE CALIF. GARDEN GRV HOBBY 6284 GRDN GROVE GARDEN GROVE, CALIF. LEES HOBBY SHOP 8751 GRDN GROVE GARDEN GROVE, CALIF. AUTO HOBBIES 3045 OCEAN VIEW GLENDALE, CALIF. VANCO HOBBY 138 S. BRAND BLVD. GLENDALE, CALIF. ROCKS TOY STORE 146 N. MICHIGAN GLENDORA, CALIF. WRIGHTS HOBBIES 5733 HOLLISTER AVE. GOLETA, CALIF. GRANADA HILLS HBY 17812 CHATSWORTH GRANADA HILLS, CALIF. VALLEY TOY TOWN 10156 N. BALLBADA GRANADA HILLS, CALIF. MOES TOY SHOP 301 N. DOUTY ST. HANFORD, CALIF. BIRDIES TOY HSE 22483 FOOTHILL HAYWARD, CALIF. JOE THE TRAIN DOCTOR 707 VINE ST. HOLLYWOOD, CALIF. REGINALD DENNY 5751 HOLLYYWD BLVD HOLLYWOOD, CALIF. HOLLYWOOD HBY 1522 CAHUENGA HOLLYWOOD 28, CALIF. OUTDOORSMAN 82 880 MILES AVE INDIO, CALIF. THE TRAINMAN 537 W. FAIRVIEW INGLEWOOD, CALIF. CRAINS TRAIN & HBY 1112 N. GLENDORA LA PUENTE, CALIF. THE TOY BIN 13907 ELLIOT LA PUENTE, CALIF. THE HOBBY HUT 980A HOUGH AVE. LAFAYETTE, CALIF. J & M GEN MDSE 10540 MAIN ST. LAMONT, CALIF. FLOYDS TOY TOWN 7923 BROADWAY LEMON GROVE, CALIF.	JERRYS HOBBY CTR 22 W. LODI AVE. LODI, CALIF. BOBS HOBBIES CRAFTS 2226 E. 4th ST LONG BEACH, CALIF. CISCOS HOBBY SHOP 4127 NORSE WAY LONG BEACH 8, CALIF. CIRCUS TOYS 163 MAIN ST. LOS ALTOS, CALIF. RANCHO HOBBY SHP 632 LOS ALTOS LOS ALTOS, CALIF. COLONEL BOBS 3707 W. PICO BLVD LOS ANGELES, CALIF. JANOHNIS 11922 SAN VICENTE LOS ANGELES 49, CALIF. IRA KATZ HOBBY STORIPAL 3313 GLENDALE BLVD. LOS ANGELES 39, CALIF. MODEL CRAFT 1082 EL CERRILLO AVE. LOS ANGELES, CALIF. NATICK STORE 209 W. 4th ST LOS ANGELES, CALIF. MADERA CRAFTS 352 S. O ST. MADERA, CALIF. ERNIES TOYLAND 418 FOURTH ST MARSYVILLE, CALIF. DONS HOBBY SHOP 1082 EL CERRILLO AVE. MENLO PARK, CALIF. MERCED CYCLERY 1621 M ST. MERCED, CALIF. JACKS MILLBRAE 209 BROADWAY MILLBRAE, CALIF. FOOTHILLS HOBBIES 343 W. FOOTHILL BLVD MONROVIA, CALIF. PLUMMER TOYTOWN 2116 FREEMONT MONTEREY, CALIF. KNAPPS TRAINS & SER. 2525 HONOLULU AVE. MONTROSE, CALIF. AERO HOBBY SHOP 19314 VANOWEN RESEDA, CALIF. VICTORS 7450 RESEDA BLVD. RESEDA, CALIF. B & B BIKES & HBYS 215 E. BASELINE ST. RIALTO, CALIF. THE TARGET 214 S. RIVERSIDE RIALTO, CALIF. CLAY'S SPT GDS. 1418 MACDONALD RICHMOND, CALIF. SKY'S HOBBY SHOP 6574 MAGNOLIA AVE. RIVERSIDE, CALIF. THE HOBBY HOUSE 2610 MARCONI AVE. SACRAMENTO, CALIF. HOBBY TOWNE 3451 WATT AVE. SACRAMENTO, CALIF. HOBBYCRAFTS 1616 JAY ST. SACRAMENTO, CALIF. TALKINS TOYLAND 5679 STOCKTON BLVD. SACRAMENTO, CALIF. TEES ARTS & HBY 6019B STOCKTON SACRAMENTO, CALIF. TEDDY BEAR TOY 921 N. MAIN ST. SALINAS, CALIF. TOYS GALORE 923 S. MAIN ST. SALINAS, CALIF. BROWNS HSE OF HBYS 562 SAN ANSELMO SAN ANSELMO, CALIF.	REEDS HOBBY SHOP 3129 HIGH ST. OAKLAND 19, CALIF. RUSSCRAFT 6015 FOOTHILL OAKLAND 5, CALIF. PALISADES HOBBY 874 VIA DE LA PAZ PAC PALISADES, CALIF. HOBBY HOUSE 440 HIGHLAND AVE. SAN BERNARDINO, CALIF. TODDS TOYS 591 SAN MATEO AVE. SAN BRUNO, CALIF. HICKORY DICKORY 785 LAUREL ST. SAN CARLOS, CALIF. J & J HOBBY HOUSE 1649 LAUREL ST. SAN CARLOS, CALIF. HALS BIKE & HBY 3087 CLAREMONT SAN DIEGO 17, CALIF. HOBBYSHOP UPTOWN 13862 CHASE ST. PANORAMA CITY, CALIF. ACE MODEL SHOP 1655 E. COLO. ST. PASADENA, CALIF. HENRIES, INC. 1726 E. COLO. B PASADENA, CALIF. WHISTLESTOP 3749 E. COLO. PASADENA 8, CALIF. LENS TOY HAVEN 227 N. MAIN ST. PORTERVILLE, CALIF. THE TOY FAIR 3957 PLACERVILLE PLACERVILLE, CALIF. THE TOY SHOP 1745 3rd ST. REDDING, CALIF. JEWELS TOY BOX 2211 ARTESIA BLVD. REDDONDO BCH, CALIF. GOETZ BROS. 2629 BROADWAY REDWOOD CITY, CALIF. AERO HOBBY SHOP 19314 VANOWEN RESEDA, CALIF. VICTORS 7450 RESEDA BLVD. RESEDA, CALIF. B & B BIKES & HBYS 215 E. BASELINE ST. RIALTO, CALIF. THE TARGET 214 S. RIVERSIDE RIALTO, CALIF. CLAY'S SPT GDS. 1418 MACDONALD RICHMOND, CALIF. SKY'S HOBBY SHOP 6574 MAGNOLIA AVE. RIVERSIDE, CALIF. THE HOBBY HOUSE 2610 MARCONI AVE. SACRAMENTO, CALIF. HOBBY TOWNE 3451 WATT AVE. SACRAMENTO, CALIF. HOBBYCRAFTS 1616 JAY ST. SACRAMENTO, CALIF. TALKINS TOYLAND 5679 STOCKTON BLVD. SACRAMENTO, CALIF. TEES ARTS & HBY 6019B STOCKTON SACRAMENTO, CALIF. TEDDY BEAR TOY 921 N. MAIN ST. SALINAS, CALIF. TOYS GALORE 923 S. MAIN ST. SALINAS, CALIF. BROWNS HSE OF HBYS 562 SAN ANSELMO SAN ANSELMO, CALIF.	SAN ANSELMO TOY 562 SAN ANSELMO SAN ANSELMO, CALIF. SPALDINGS 800 SAN ANSELMO SAN ANSELMO, CALIF. FIRESIDE CYCLE 1575 E. HIGHLAND SAN BERNARDINO, CALIF. HOBBY HOUSE 440 HIGHLAND AVE. SAN BERNARDINO, CALIF. TODDS TOYS 591 SAN MATEO AVE. SAN BRUNO, CALIF. HICKORY DICKORY 785 LAUREL ST. SAN CARLOS, CALIF. J & J HOBBY HOUSE 1649 LAUREL ST. SAN CARLOS, CALIF. HALS BIKE & HBY 3087 CLAREMONT SAN DIEGO 17, CALIF. HOBBYSHOP UPTOWN 13862 CHASE ST. PANORAMA CITY, CALIF. ACE MODEL SHOP 1655 E. COLO. ST. PASADENA, CALIF. HENRIES, INC. 1726 E. COLO. B PASADENA, CALIF. WHISTLESTOP 3749 E. COLO. PASADENA 8, CALIF. LENS TOY HAVEN 227 N. MAIN ST. PORTERVILLE, CALIF. THE TOY FAIR 3957 PLACERVILLE PLACERVILLE, CALIF. THE TOY SHOP 1745 3rd ST. REDDING, CALIF. JEWELS TOY BOX 2211 ARTESIA BLVD. REDDONDO BCH, CALIF. GOETZ BROS. 2629 BROADWAY REDWOOD CITY, CALIF. AERO HOBBY SHOP 19314 VANOWEN RESEDA, CALIF. VICTORS 7450 RESEDA BLVD. RESEDA, CALIF. B & B BIKES & HBYS 215 E. BASELINE ST. RIALTO, CALIF. THE TARGET 214 S. RIVERSIDE RIALTO, CALIF. CLAY'S SPT GDS. 1418 MACDONALD RICHMOND, CALIF. SKY'S HOBBY SHOP 6574 MAGNOLIA AVE. RIVERSIDE, CALIF. THE HOBBY HOUSE 2610 MARCONI AVE. SACRAMENTO, CALIF. HOBBY TOWNE 3451 WATT AVE. SACRAMENTO, CALIF. HOBBYCRAFTS 1616 JAY ST. SACRAMENTO, CALIF. TALKINS TOYLAND 5679 STOCKTON BLVD. SACRAMENTO, CALIF. TEES ARTS & HBY 6019B STOCKTON SACRAMENTO, CALIF. TEDDY BEAR TOY 921 N. MAIN ST. SALINAS, CALIF. TOYS GALORE 923 S. MAIN ST. SALINAS, CALIF. BROWNS HSE OF HBYS 562 SAN ANSELMO SAN ANSELMO, CALIF.	HOBBY HAVEN 214 SO. B ST. SAN ANSELMO, CALIF. MACYS HILLDALE EL CAMINO RD. SAN MATEO, CALIF. NOTHING BUT TRAIN 132 W. 25th AVE. SAN MATEO, CALIF. STANTONS TOYS 15 E. FOURTH AVE. SAN MATEO, CALIF. TALBOTS TOYLAND FIFTH & G STS. SAN MATEO, CALIF. TOY PALACE 861 FOURTH ST. SAN RAFAEL, CALIF. JACK IN THE BOX 5209 STEVENS CREEK SANTA CLARA, CALIF. SANTA CLARA HBY 1165 FRANK MONICA SANTA CLARA, CALIF. TOY BOX 1123 SOOUEL AVE. SANTA CRUZ, CALIF. SMITH ARTS CRAFTS 1132 PACIFIC AVE. SANTA CRUZ, CALIF. CAMERA HBY CTR. 1722A S. BWAY SANTA MARIA, CALIF. ROSS CROP DUSTERS 3515 DICKSON DR. SANTA MARIA, CALIF. AERO HOBBIES 1390 SANTA MONICA SANTA MONICA, CALIF. EVETTS MODEL SHOP 1636 OCEAN PK BLVD. SANTA MONICA, CALIF. SHELDON WALLACE 5250 SANTA MONICA SANTA MONICA, CALIF. AARDAPPELS TOYVILLE 866 MAIN ST. SANTA PAULA, CALIF. HALS TOYVILLE 2316 MONTGOMERY SANTA ROSA, CALIF. DEES HBY & GIFT SHP 1266 FREMONT BLVD SEASIDE, CALIF. HARRY'S TOY SHOP 4511 MISSION ST. SAN FRANCISCO, CALIF. SELMA, CALIF. NELSONS HARDWARE 1951 HIGH ST. SAN FRANCISCO, CALIF. SELMA, CALIF. THE HOBBY CENTER 5733 GEARY BLVD. SAN FRANCISCO, CALIF. SOUTH GATE, CALIF. HILTONS HOBBY HOUSE 1501 MISSION ST. SAN FRANCISCO, CALIF. SO. PASADENA, CALIF. HOBBY CRAFT SHP 637 E. MAIN ST. STOCKTON, CALIF. LINDYS TOY FAIR 347 W. WASHINGTON SUNNYVALE, CALIF. THE ENGINE HOUSE 20844 ALBERTA AVE. SUNNYVALE, CALIF. WALT'S MDL HANGAR 411 E. ARQUES AVE. SUNNYVALE, CALIF. GILBERTS TOY & HBY 2238 PALOS VERDES TORRANCE, CALIF. TRACY HBY & TOY 128 W. 10th ST. TRACY, CALIF. COOPER TOYS & HBY 138 SO. K TULARE, CALIF. YOUNGDALES, INC. 250 MARKET ST. TURLOCK, CALIF. ZBITNOFF MUSIC 5 HWY & LEWIS LA UKIAH, CALIF. STILLINGS BRO. 337 GEORGIA ST. VALLEJO, CALIF.
---	---	--	---	---	--	---	---

SEE BOTTOM OF PAGE 31 FOR LATEST SERVICE STATION ADDITIONS IN YOUR STATE.

CLINTS HBYS  
14831 BURBANK  
VAN NUYS, CALIF.

FLYING TIGER HBY  
14520 VICTORY  
VAN NUYS, CALIF.

THE HOBBY HOUSE  
16842 SATICUM  
VAN NUYS, CALIF.

BOB SUARTS TOYLAND  
2571 E. MAIN  
VENTURA, CALIF.

VENTURA TOYS  
230 E. MAIN ST.  
VENTURA, CALIF.

JOHN SCRUBY  
2044 S. LINWOOD  
VISALIA, CALIF.

VISALIA TOYS  
115 N. ENGINA  
VISALIA, CALIF.

BIRDS TOYS  
1248 BROADWAY  
WALNUT CREEK, CALIF.

BROWNS HBY CTR  
1356 N. MAIN ST.  
WALNUT CREEK, CALIF.

WALTERIA TOY SHOP  
24242 HAWTHORNE  
WALTERIA, CALIF.

STUARTS PHARMACY  
17635 SHERMAN WAY  
VAN NUYS, CALIF.

JACKS HOBBY CRAFTS  
8441 S. CENTRAL AVE.  
WHITTIER, CALIF.

SARGENTS SPTS & HBYS  
214 N. GREENLEAF  
WHITTIER, CALIF.

OLSONS HOBBY  
810 MAIN ST.  
WOODLAND, CALIF.

THE TOY HOUSE  
624 SHASTA ST.  
YUBA, CITY, CALIF.

**COLORADO**

NARROW GAUGE HOBBY  
ROUTE 2  
ALAMOSA, COLO.

THE TRAIN SHOP  
1518 FLORENCE ST.  
AURORA 8, COLO.

WHITCRAFT  
2046 14th ST.  
BOULDER, COLO.

LINDNERS HOBBY  
149 N. COLLEGE  
FT. COLLINS, COLO.

ARTS CRAFTS & HBY  
8 E. PIKES PEAK AVE.  
COLO. SPRINGS, COLO.

HOBBYLAND  
110 S. TEJON  
COLO. SPRINGS, COLO.

THE MUSICK DRUG  
309 E. FONTANERO  
COLO. SPRINGS, COLO.

ANDERSONS TOY  
CHERRY CRK SHIP CTR  
DENVER, COLO.

BONNIE BRAE HOBBY  
705 N. UNIVERSITY  
DENVER, COLO.

CABOSE HOBBIES  
610 15th ST.  
DENVER, COLO.

DOWNTOWN TOYS & HBY  
1517 CHAMPA ST.  
DENVER 2, COLO.

HO TRAINS & ACCESS  
51 W. ALAMEDA  
DENVER 23, COLO.

GUY'S DOLLS  
6200 E. COLFAX  
DENVER, COLO.

J & H HOBBY HUT  
320 S. HARLAN  
DENVER, COLO.

MAYOS HOBBY CTR.  
1010 S. FEDERAL  
DENVER, COLO.

THE PLANET TOY  
3100 S. SHERIDAN  
DENVER, COLO.

TOM THUMB HOBBIES  
7020 E. COLFAX  
DENVER 20, COLO.

TOY MENAGERIE  
2021 S. FEDERAL  
DENVER, COLO.

TOY WORLD, INC.  
2474 S. COLORADO  
DENVER, COLO.

ELECTRIC TRAINS  
7070 GARDEN COURT  
DERBY, COLO.

NIELSEN'S HBBYLAND  
1041 MAIN AVE.  
DURANGO, COLO.

HOBBY LOBBY  
3360 SO. BROADWAY  
ENGLEWOOD, COLO.

EVERGREEN HOBBIES  
P. O. BOX 521  
EVERGREEN, COLO.

LINDNERS HOBBY  
149 N. COLLEGE AVE.  
FT. COLLINS, COLO.

HOBBY HAVEN  
627 8th AVE.  
GREELEY, COLO.

RITCHEYS  
829-833 8th ST.  
GREELEY, COLO.

BAILEYS TOY TOWN  
414 COLORADO AVE.  
LA JUNTA, COLO.

KARRER CARD & GIFT  
321 MAIN ST.  
LAKEWOOD, COLO.

LAKEWOOD HOBBY  
8809 W. COLFAX  
LAKEWOOD 15, COLO.

TOY MENAGERIE  
10405 W. COLFAX  
LAKEWOOD, COLO.

WHITNEY'S HOBBY  
221 S. MAIN  
LAMAR, COLO.

BROOKRIDGE HOBBIES  
5146 S. BRDWAY  
LITTLETON, COLO.

LITTLE TOWN HOBBY  
WOODLAWN SHOPPETTE  
LITTLETON, COLO.

BOBS TOY CHEST  
360 MAIN ST.  
LONGMONT, COLO.

LONGMONT CYCLE  
313 MAIN ST.  
LONGMONT, COLO.

HOBBY CRAFT  
607 N. MAIN ST.  
LONGMONT, COLO.

SKAGGS DRUG CTR.  
408 N. MAIN  
PUEBLO, COLO.

SMALL OIL CO.  
RIFLE, COLO.

UNCLE HANKS TOYS  
7301 N. FEDERAL  
WESTMINSTER, COLO.

MODERN HARDWARE  
431 WADSWORTH  
WHEATRIDGE, COLO.

**CONNECTICUT**

ARTCRAFT ART & HBY  
ROUTE 2  
JACKSONVILLE 10, CONN

B & W HOBBIES  
263 GREENWOOD AVE.  
BETHEL, CONN.

BRANFORD HOBBIES  
BOSTON POST ROAD  
BRANFORD, CONN.

BLINNS, INC.  
64 CANNON ST.  
BRIDGEPORT, CONN.

BOBS SHOP  
1542 WOOD AVE.  
BRIDGEPORT 5, CONN.

FREDS VARIETY  
184 SUCCESS AVES.  
BRIDGEPORT, CONN.

TRAIN EXCHANGE  
631 FAIRFIELD AVE.  
BRIDGEPORT, CONN.

IRV YURDINS TRAIN  
31 FAIRFIELD AVE.  
BRIDGEPORT 3, CONN.

BRISTOL HOBBY CTR.  
43 MIDDLE ST.  
BRISTOL, CONN.

R. J. CASEYS  
196 MAIN ST.  
CHESHIRE, CONN.

HOUSE OF HOBBIES  
125 NASHAWENA AVE.  
WEST HAVEN, CONN.

HOBBY HOUSE  
276 MAIN ST.  
DANBURY, CONN.

TOBYS HOBBY CTR  
1032 POST RD.  
DARIEN, CONN.

BLINNS CAROUSEL  
1435 POST RD.  
FAIRFIELD, CONN.

FAIRFIELD HBY SHOP  
43 UNQUOWA RD.  
FAIRFIELD, CONN.

MOTOR POST  
349 GREENWICH AVE.  
GREENWICH, CONN.

THE SPORT SHOP  
151 GREENWICH AVE.  
GREENWICH, CONN.

LEES  
987 POGOJNOCK RD.  
GROTON, CONN.

EDS ENTERPRISES  
258 RIVER ST.  
GUILFORD, CONN.

COBBS  
210 DIXWELL AVE.  
HAMDEN, CONN.

HOBBY CENTER  
222 PEARL ST.  
HARTFORD, CONN.

HOBBY CIRCLES, INC.  
602 WASH. RD.  
HAZARDVILLE, CONN.

BOBS PET & HOBBY  
185 SOUND BCH AVE.  
OLD GREENWICH, CONN

HOBBY SHOPPE  
403 CENTER ST.  
MANCHESTER, CONN.

PLAY PEN  
34 PRATT ST.  
MERIDEN, CONN

J. R. STEEL, INC.  
42 E. MAIN ST.  
MERIDEN, CONN

AMATOS, INC.  
420 MAIN ST.  
MIDDLETOWN, CONN.

JOES HOBBY SHOP  
55 W. CLIFTON  
MILFORD, CONN.

EDS HOBBY SHOP  
14 CHURCH ST.  
NAUGATUCK, CONN.

AMATOS  
220 MAIN ST.  
NEW BRITAIN, CONN.

AMAZING SALES  
30 CHURCH ST.  
NEW BRITAIN, CONN.

HOBBYLAND  
59 ELM ST.  
NEW CANAAN, CONN.

HULLS HOBBY  
1203 CHAPEL  
NEW HAVEN, CONN.

LEES KIDDYLAND  
237 BANK ST.  
NEW LONDON, CONN.

JOSEPH L. RAUB  
2521 HOPMEADOW  
NEW LONDON, CONN.

NEW MILFORD HBY  
4 NICHOLAS SQ.  
NEW MILFORD, CONN.

KIDDYTOWN, INC.  
62 WALL ST.  
NORWALK, CONN.

CAMPBELLS  
3 MARKET ST.  
NORWICH, CONN.

SHORELINE ART CTR.  
104 WASHINGTON ST.  
OLD SAYBROOK, CONN.

MARTINS HBY SHOP  
RFD 1  
PLANTSVILLE, CONN.

WESTERN AUTO ASSOC.  
37 FRONT ST.  
PUTNAM, CONN.

BOBS SPORTING GDS.  
2631 HOPMEADOW  
SIMSBURY, CONN.

NATIONAL STORES  
23 MAIN ST.  
STAFFORD SPRINGS, CONN

HOBBY CRAFTS  
235 MAIN ST.  
STAMFORD, CONN.

MAX K. TRELL  
513 SUMMER ST.  
STAMFORD, CONN.

TRAIN EXCHANGE CTR  
100 MAIN ST.  
STRATFORD, CONN.

WESTERN AUTO  
46 PEARL ST.  
THOMPSONVILLE, CONN

LARAIAS MOD & HBY  
MAIN & WATER ST.  
TORRINGTON, CONN.

WESTERN AUTO  
LEON S. MALCOLM  
TORRINGTON, CONN.

FUSS SALES  
26 LASALLE RD.  
W. HARTFORD 7, CONN.

WEST CRAFT HOBBY  
135 E. STATE ST.  
WESTPORT, CONN.

BOYDS CENTER STORE  
WILTON CENTER  
WILTON, CONN.

NEWS & HBY SHOP  
1 DANBURY ROAD  
WILTON, CONN.

**DELAWARE**

TRIMPERS TOYLAND  
RT. 113  
DAGSBORO, DEL.

DORSMAN'S  
4713 KIRKWOOD HWY  
WILMINGTON 8, DEL.

MITCHELLS  
2119 CONCORD PIKE  
WILMINGTON, DEL.

VANDEVERS HBY CTR.  
909 TATNALL ST.  
WILMINGTON, DEL.

DISTRICT OF COLUMBIA

EASTOVER SPT & HBY  
4875 INDIAN HEAD  
WASH. 21, D. C.

HOBBY HDOTRS  
4301 BRANCH AVE SE  
WASH. 23, D. C.

KAY CEE DRUGS  
5562 SILVER HL. RD.  
WASHINGTON, D. C.

**FLORIDA**

CORTEZ TOY & HBY  
CORTAZ PLAZA  
BRADENTON, FLA.

HOUSE OF HOBBIES  
1118 S. FT. HARRISON  
CLEARWATER, FLA.

TOY CHEST  
BYRD PLAZA SHIP CTR.  
COCOA, FLA.

DUN BROS. HDWE  
154 S. BEACH ST.  
DAYTONA BCH., FLA.

KIDDIE KORNER  
122 N. NOVA RD.  
DAYTONA BCH., FLA.

TOODLE TOWN  
149 NE 2nd ST.  
DELRAY BCH, FLA.

HOBBY HOUSE  
1518 S. DIXIE HWY  
EAU GALIE, FLA.

MISSILE TOY & HBY  
S. PATRICK SHIP CTR  
EAU GALIE, FLA.

JOLLYS  
915 MAIN ST.  
GAINESVILLE, FLA.

GATEWAY TOY & HBY  
248 WASH. AVE.  
FT. LAUDERDALE, FLA.

UNIVERSAL HOBBIES  
141 S. STATE RD. 7  
FT. LAUDERDALE, FLA.

FT. MYERS HOBBIES  
1611 JACKSON ST.  
FT. MYERS, FLA.

COWGERS TOY & HBY  
1303 DELAWARE  
FT. PIERCE, FLA.

FRANK CO.  
417 S. EDGEMOOR  
FT. PIERCE, FLA.

SAMS HBY SUP & COIN  
167 E. MAIN ST.  
FT. WALTON BCH., FLA.

SHELLS HOBBY SHOP  
5480 PALM AVE.  
HIALEAH, FLA.

SPORTSMAN OF HMST  
428 WASH. AVE.  
HOMESTEAD, FLA.

ARTS HOBBY SHOP  
1024 ATLANTIC BLVD  
JACKSONVILLE 16, FLA.

MARKS HOBBY SHOP  
2033 ROGERO RD.  
JACKSONVILLE, FLA.

OAK ROCK SALES  
3524 MAYFLOWER ST.  
JACKSONVILLE, FLA.

TOYTOWN, INC.  
2525 W. BROADWAY  
JACKSONVILLE, FLA.

THE BOOK CASE  
LAKE CITY PLAZA #8  
LAKE CITY, FLA.

WORRELL OF TOYS  
656 E. WELCH HWY  
MADEIRA BCH, FLA.

HENDRICH HOBBY SHOP  
329 NEW HAVEN AVE.  
MELBOURNE, FLA.

ALJO HOBBIES  
CUTLIP RIDGE SHOP  
MIAMI 57, FLA.

CORAL WAY GIFT SHOP  
6600 SW 24th ST.  
MIAMI, FLA.

THE HBBY CENTER  
3621 SW 8th ST.  
MIAMI, FLA.

RANGE BLSM HOBBY  
1896 N. W. 36th ST.  
MIAMI, FLA.

ANN & RUBE MEYERS  
1430 NE 163rd ST.  
MIAMI BCH, FLA.

TOBYS TOYLAND, INC.  
14259 NW 7th AVE.  
N. MIAMI, FLA.

COLONIAL PHOTO HBY  
636-38 N. MILLS ST.  
ORLANDO, FLA.

FUN LAN TOYS  
259-63 E. MICH. AVE.  
ORLANDO, FLA.

MOSES PHARMACY  
1201 W. COLONIAL  
ORLANDO, FLA.

VIDEO SONICS, INC.  
1321 W. FAIRBANKS  
ORLANDO, FLA.

GULF COAST MERC.  
315-17 S. PALAFOX  
PENSACOLA, FLA.

ROGERS TOY SHOP  
TOWN & COUNTRY  
PENSACOLA, FLA.

BARON'S TOYS  
11521 SO. DIXIE HWY  
PERRINE, FLA.

KANES SPORT SHOP  
3529 N. FEDERAL  
POMPANO BCH, FLA.

POMPANO BIKE & TOY  
1786 N. FEDERAL  
POMPANO BCH, FLA.

RIVIERA TOY & HBY  
2745 BROADWAY  
RIVIERA BCH, FLA.

TOY BOX  
924 SW 2nd ST. NORTH  
ST. PETERSBURG, FLA.

TOY KING  
4314 6th ST. S  
ST. PETERSBURG, FLA.

TOY KING 103  
6852 GULFPORT BLVD  
ST. PETERSBURG, FLA.

TOY CORRAL  
2619 FRENCH AVE.  
SANFORD, FLA.

CRAWFORD'S HBYS  
112 N. RAY ST.  
EUSTIS, FLA.

MODEL HBY SHOP  
153 ASPREY  
SARASOTA, FLA.

SUNSET HOBBIES  
5842 SUNSET AVE.  
S. MIAMI, FLA.

LEES HOBBY SHOP  
32 E. OCEOLA ST.  
STUART, FLA.

LITTLE FOLKS STORE  
133 N. MONROE ST.  
TALLAHASSEE, FLA.

CHAN'S AFFILIATES, INC.  
1111 HENDERSON BLVD.  
TAMPA, FLA.

DAVIS PHARMACY  
232 E. DAVIS BLVD.  
TAMPA, FLA.

DIXIE HOBBY SHOP  
4703 NEBRASKA AVE.  
TAMPA, FLA.

FARMERS SUNDRIES  
452 SO. BROADWAY  
TAMPA, FLA.

FULMER DRUG STORE  
4201 20th ST.  
VERO BEACH, FLA.

RIMES TOY & HBY  
5847 TAFT ST.  
W. HOLLYWOOD, FLA.

CYCLE CENTER  
3525 W. PALM BCH, FLA.

H & B SUPPLY CO.  
405 S. OLIVE AVE.  
W. PALM BCH, FLA.

HARRY'S TOY SHOP  
401 S. OLIVE AVE.  
W. PALM BCH, FLA.

McKINLEYS VAR. STR  
6405 S. DIXIE  
W. PALM BCH, FLA.

RIMES TOYS  
2525 W. PALM BCH, FLA.

HAVEN HOBBY HSE  
238 AVE. A NW  
WINTER HAVEN, FLA.

EASTGATE TOY  
1933 ALOMA AVE.  
WINTER PARK, FLA.

**GEORGIA**

DOZIER'S SPORTS  
208 PINE  
ALBANY, GA.

HOBBY CRAFTS  
ALBANY, GA.

FISHE TOY CO.  
2581 PIEDMONT RD.  
ATLANTA 5, GA.

LENOX HOBBY  
3393 PEACHTREE NE  
ATLANTA, GA.

McELMURRAY & CO.  
850 ELLIS ST.  
AUGUSTA, GA.

WESTERN AUTO ASSOC.  
W. WEAVER  
BLUE RIDGE, GA.

DECATUR HOBBY SHP  
128 CHURCH ST.  
DECATUR, GA.

GIBBS HDWE & HBY  
2097 N. DECATUR  
DECATUR, GA.

FISHER HDWE & SUP  
123 N. MONROE  
GRIFFIN, GA.

MACON HOBBY SHOP  
456-58 CHERRY ST.  
MACON, GA.

TOYS & THINGS  
WESTGATE SHPG CTR  
MACON, GA.

MIKES HOBBY SHOP  
204 W. 11th ST.  
ROME, GA.

THE HOBBY SHOP  
MED. ARTS SHP CTR.  
SAVANNAH, GA.

THOMAS TOYS & HBYS  
2130 E. VICTORY  
SAVANNAH, GA.

LESLIE R. DAVIS  
115 N. ASHLEY ST.  
VALDOSTA, GA.

PLAYLAND STORES  
ROCKWOOD PLAZA  
VALDOSTA, GA.

PLAYLAND TOY STORES  
418 E. PARK AVE.  
VALDOSTA, GA.

**HAWAII**

CYRILS HBY & BIKE  
WAIALAE SHOPPING  
HONOLULU, HAWAII

TEDS HOBBY SHOP  
1079 S. BEVETANIA  
HONOLULU, HAWAII

WAIPAHU BIKE & SPT  
410 W. 26th ST.  
WAIPAHU, HAWAII

**IDAHO**

KNIGHTS HOBBY SHOP  
1500 N. GARDEN  
BOISE, IDAHO

WHITNEY HBY HSE  
930 VISTA AVE.  
BOISE, IDAHO

SAV MOR DRUG  
1005 MAIN  
BUTTE, IDAHO

CRAFT & HBY SHOP  
420 SHERMAN AVE.  
COEUR D'ALENE, IDAHO

TRADE WINDS  
552 PARK AVE.  
IDAHO FALLS, IDAHO

CORNER DRUG  
201 MAIN  
KELLOGG, IDAHO

HIRZELS  
720 MAIN  
LEWISTON, IDAHO

ORCHARDS JEWELRY  
536 THAIN N  
LEWISTON, IDAHO

REUBENS FIXIT SHOP  
119 E. 8th ST.  
MOSCOW, IDAHO

HARRIS DEPT. STORE  
290 E. JACKSON  
MT. HOME, IDAHO

DICKS SPT & HBY  
1005 S.  
POCATELLO, IDAHO

GATEWAY CYCL & KY  
314 N. MAIN  
POCATELLO, IDAHO

THE HOBBY CTR  
325 E. MAIN  
TWIN FALLS, IDAHO

**ILLINOIS**

BELLS HBY SHOP  
1636 WASH.  
ALTON, ILL.

CARDIS CYCLE & HBY  
410 W. KE ST.  
ANTIOCH, ILL.

THE TOY & HBY HSE  
27 N. CAMPBELL  
ARLINGTON HTS, ILL.

AURORA CYCLE & HBY  
68 S. BDWY  
AURORA, ILL.

DARKENS  
107 W. MAIN ST.  
BARRINGTON, ILL.

LANGES BIKE SHOP  
120 W. MAIN ST.  
BARRINGTON, ILL.

THE TOY SHOP  
JEWEL CENTER  
BARRINGTON, ILL.

BILLMEIER HBY SHOP  
715 E. MAIN  
BELLEVILLE, ILL.

HARTERS HOBBY HSE  
401 W. MT. MOROE  
BELLEVILLE, ILL.

REMIK HDWE CO.  
48th & WEST MAIN  
BELLEVILLE, ILL.

VILLAGE TOY CENTER  
115 W. MAIN  
BENSENVILLE, ILL.

BOBS HOBBY SHOP  
112 W. WALNUT ST.  
BLOOMINGTON, ILL.

MURRAYS HOBBYLAND  
1112 N. MAIN  
BLOOMINGTON, ILL.

LEES FIX IT SHOP  
8863 BURLINGTON  
BROOKFIELD, ILL.

McCLUCKIE'S STORE  
34 W. SIDE SQ.  
CANTON, ILL.

EASTERLY PAINT STR.  
201 W. MONROE  
CARBONDALE, ILL.

M. ERICKSON HBY  
MEADOWLW SHP CTR.  
CARPENTERSVILLE, ILL.

STEDLINS TOYLAND  
124 S. LINCOLN  
CENTRALIA, ILL.

FAIRCHILD CAM & HBY  
111 N. WALNUT  
CHAMPAIGN, ILL.

SE US SUPPLY, INC.  
901 S. NEIL ST  
CHAMPAIGN, ILL.

ACME CYCLE HBY  
8125 S. COTTAGE  
CHICAGO, ILL.

ALL BRITE PHOTO  
6824 ARCHER  
CHICAGO, ILL.

ASCO HOBBY  
3512 S. HALSTED  
CHICAGO, ILL.

AUSTIN PHOTO & HBY  
520 W. FULLERTON  
CHICAGO, ILL.

BILLS HOBBY SPORT  
7376 W. FULLERTON  
CHICAGO 47, ILL.

B & C HOBBY SHOP  
410 W. 26th ST.  
CHICAGO, ILL.

B & E HOBBY CRAFTS  
3531 N. WESTERN  
CHICAGO, ILL.

BENNY HOBBY SUP.  
975 W. BELMONT  
CHICAGO, ILL.

BLOORES HBY & TOY  
3645-49 E. 106 ST.  
CHICAGO 17, ILL.

BREWERS HOBBYLAND  
2550 IRVING PK RD  
CHICAGO, ILL.

THE FAIR HOBBY  
STATE AT ADAMS  
CHICAGO, ILL.

GLIDERS BIKE & HBY  
1035 W. 79th ST.  
CHICAGO, ILL.

H & N HOBBY SHOP  
4106 N. PULASKI RD  
CHICAGO 41, ILL.

HOBBIES & SPORTS  
1755 W. 95th ST.  
CHICAGO 43, ILL.

HOBBY HAVEN  
5619 N. GLENWOOD  
CHICAGO 40, ILL.

ART'S CYCLE & HBY  
1710 EAST 87th ST.  
CHICAGO 17, ILL.

HOBBY HOUSE  
5516 SO. AMEN  
CHICAGO, ILL.

THE HOBBY HUT  
2734 W. TOUGHY  
CHICAGO 45, ILL.

HOBBY JUNCTION  
2840 LARAMIE  
CHICAGO 41, ILL.

HOBBY SERV. & SUP  
6 E. RANDOLPH ST.  
CHICAGO, ILL.

HOBBY CRAFT CTR  
1621 E. 87th ST.  
CHICAGO 17, ILL.

HOBBYMODELS, INC.  
27 N. CAMPBELL  
CHICAGO, ILL.

HOBBYVILLE  
3838 N. CICERO  
CHICAGO, ILL.

KENYONS 5 & 1.00 ST.  
12844 S. HALSTED  
CHICAGO, ILL.

LEE CRAFT CO.  
4705 W. 79 ST.  
CHICAGO 52, ILL.

LINKAS STATY & SPT  
3918 W. 26th ST.  
CHICAGO 23, ILL.

M & G HBY & CYCLE  
3445 N. PULASKI  
CHICAGO 41, ILL.

MICHIGAN HOBBY  
11216 S. MICHIGAN  
CHICAGO, ILL.

TONY'S HOBBY SHOP  
6108 NO. WEST HWY  
CHICAGO, ILL. 60631

PILOT PAINT & VAR.  
5450 W. BELMONT  
CHICAGO 41, ILL.

ROBERTS CYCLE CO.  
7053 N. CLARK  
CHICAGO, ILL.

SHALLCROSS HOBBIES  
6324 N. CENTRAL  
CHICAGO 46, ILL.

SIMONSEN MODEL SUP.  
3054 N. GREENVIEW  
CHICAGO, ILL.

STANTON HOBBY  
4736 N. WILWAUKEE  
CHICAGO, ILL.

STU DE JONG & SON  
34 E. 112th PLACE  
CHICAGO, ILL.

W. TOWNS HBY SHOP  
5808 W. CHICAGO  
CHICAGO 18, ILL.

WIELGUS SPT & HBY  
3230 W. IRVING  
CHICAGO 18, ILL.

TOYLAND  
10900 S. WESTERN  
CHICAGO, ILL.

TROST MODE SHOP  
3111 W. 63rd ST.  
CHICAGO, ILL.

VAN BOSKIRKS SHOP  
7334 S. HALSTED  
CHICAGO, ILL.

VEES QUALITY SERV.  
5555 W. ASHLAND  
CHICAGO 22, ILL.

VILLAGE HOBBY SHOP  
6824 ARCHER  
CHICAGO, ILL.

ZENITH HOBBY SHOP  
5155 W. 11th ST.  
CHICAGO, ILL.

AIRPLANE MDL & HBY  
6129 CERMAK RD.  
CICERO, ILL.

SVEHLA AWNING  
5941-43 W. 35 ST.  
CICERO, ILL.

YOUNGS VARIETY  
19 WALKER  
CLAREMONT HLS, ILL.

KRAMER BROS.  
407 W. INGLIS  
COLLINGSVILLE, ILL.

FRANKS BARBER TOY  
113 N. MAIN ST.  
CRYSTAL LAKE, ILL.

WILSONS HBY SHOP  
22 W. NORTH ST.  
DANVILLE, ILL.

BOLAYS HOBBIES  
107 111 N. MAIN ST.  
DECATUR, ILL.

BLOCK & CO. HDWE  
125 E. NORTH  
DECATUR, ILL.

HOBBY HOUSE  
124 E. PRAIRIE ST.  
DECATUR, ILL.

TOY CASTLE  
734 WAUKGAN  
DEERFIELD, ILL.

CHILTONS SPORTING  
248 E. LINCOLN HWY  
DE KALB, ILL.

JACKS JUVENILE SHOP  
5719 N. LINCOLN HWY  
DE KALB, ILL.

MASTER HOBBIES  
1410 PRAIRIE AVE.  
DES PLAINES, ILL.

TOY & HBY SHOP  
1486 MINER ST.  
DES PLAINES, ILL.

ARTS HOBBY CTR  
1533 MAIN ST.  
DOWNERS GRV., ILL.

WILSHIRE HOBBY  
WILSHIRE VILLAGE  
EAST ALTON, ILL.

HOBBIES GALORE  
3821 MAIN ST.  
E. CHICAGO, ILL.

ABC HOBBY CRAFT  
5914 W. STE. ST.  
E. ST. LOUIS, ILL.

EAST SIDE HOBBIES  
2303 STATE ST.  
E. ST. LOUIS, ILL.

SCHISKLERS HOBBY  
5 E. CHICAGO ST.  
ELGIN, ILL.

JOS. SPRESS CO.  
38 S. GROVE  
ELGIN, ILL.

JERRELS HDWE  
ELIZABETHTOWN, ILL.

ALS HOBBY SHOP  
109 ADDISON AVE.  
ELMHURST, ILL.

DISPENSA & SONS  
1 S. 151 RT. 83  
ELMHURST, ILL.

TOY & HBYTOWN  
2440 N. HARLEM  
ELMWOOD PK, ILL.

HOBBY CHEST  
713 HOWARD ST.  
EVANSTON, ILL.

HOBBY CHEST  
615 HOWARD ST.  
EVANSTON, ILL.

HOBBYMODELS  
601 DAVIS ST.  
EVANSTON, ILL.

TOYTOWN CO.  
3223 W. 95th ST.  
EVERGREEN PK, ILL.

NEWS STAND  
206 ADDISON AVE.  
FAIRFIELD, ILL.

MESSING & BECKER  
18 SOUTH GALENA  
FREEPORT, ILL.

TOYAND USA  
22 S. CHICAGO  
FREEPORT, ILL.

GALE WARD ATHL  
39 N. PRAIRIE  
GALESBURG, ILL.

KIDDIE KORNER  
3 EAST MAIN  
GALESBURG, ILL.

CAMPBELLS DEPT ST.  
118-20 S. STATE  
GENESE, ILL.

GLEN ELLYN NEWS  
476 MAIN ST.  
GLEN ELLYN, ILL.

BELLMORE TOY & SPT  
3220 NOMEAKE  
GRANITE CITY, ILL.

GRAND PRY  
2125 MERIDIAN  
GRT. LAKES, ILL.

CARLSON SPT GDS.  
73 NORTH AYER  
HARVARD, ILL.

CHUCKS HBY HOUSE  
239 E. 147th ST.  
HARVEY, ILL.

L & M TOYLAND  
193 E. 154th ST.  
HARVEY, ILL.

JAYS TOYS  
1916 BREMERTON PL.  
HAZEL REST, ILL.

MEISHNERS  
409 EDWARD ST.  
HENRY, ILL.

UHL'S SPORT GDS 204 N. 5th BEATRICE, NEB.

KIDDIES KLOS 221 MISSION BELLEVUE, NEB.

GARY'S TOY CASTLE 1355 26 AVE. COLUMBUS, NEB.

DODDS DEPT. STORE COZARD, NEB.

GENES HOBBY HUT 517 FAIRBURY, NEB.

DICKS HBY SHOP 218 N. DENVER HASTINGS, NEB.

BOBS KIDDIE KASTEL 714 E. SIDE BLVD HASTINGS, NEB.

KLONES SPTG GDS 2213 CENTRAL AVE. KEARNEY, NEB.

AERO DESIGN 1212 S. 10th ST. LINCOLN, NEB.

HOBBY TOWN 134 N. 13th ST. LINCOLN 8, NEB.

TOY CASTLE 1323 3rd ST. LINCOLN, NEB.

FISHERS WORLD TOY MCCOOK, NEB.

CAAWVE'S 103 NO. 4th ST. NORFOLK, NEB.

YOUNGS SPT GDS. 5th AND JEFFERS N. PLATTE, NEB.

SULLIVAN DEPT STR OGALLALA, NEB.

BABYTOWN CRSSRDS 72nd & DODGE STS OMAHA, NEB.

HOBBY CENTER 6111 MILITARY OMAHA, NEB.

THILLS 5112 SO. 24th ST. OMAHA, NEB.

WIGHT HBY SHOP 107 N. 49th ST. OMAHA, NEB.

RUSSELL SPTG 1816 FARNAM ST. OMAHA 2, NEB.

JAYS HBY HUT 121 W. FIRST ST. PAPIILLON, NEB.

TOY CASTLE 1811 BROADWAY SCOTTSBLUFF, NEB.

JACKSON DEPT. ST. TRENTON, NEB.

NEVADA

THE SPORTSMAN 350 N. VIRGINIA RENO, NEVADA

NEW HAMPSHIRE

WESTERN AUTO ASSOC. 255 MAIN ST. BERLIN, N. H.

LAMBERTS CYCLE NORTH ST. CLAREMONT, N. H.

TOY CASTLE 53 NORTH ST. CLAREMONT, N. H.

FRENCHS RADIO SHP 10 N. STATE ST. CONCORD, N. H.

CONWAY HBY CTR MAIN ST. CONWAY, N. H.

WESTERN AUTO 296 CENTRAL DOVER, N. H.

HOITT & WENTWORTH 559 CENTRAL AVE. DOVER, N. H.

RABERGE PHOTO SHP 129 WATER ST. EXTER, N. H.

ANDYS AUTO STORE 99 MAIN ST. KEENE, N. H.

GREENLAWNS MUSIC MAIN ST. LACONIA, N. H.

LACONIA HDWE 560 MAIN ST. LACONIA, N. H.

NH BUYERS SERV. 1028 ELM ST. MANCHESTER, N. H.

PHILIP MORRIS CO. MAIN & EAST PEARL NASHUA, N. H.

A. M. RAND CO. 67 MAIN ST. PLYMOUTH, N. H.

NEW ENG. HBY & SPT 94 W. PEARL ST. NASHUA, N. H.

GALLAGHERS 86 PLEASANT ST. PORTSMOUTH, N. H.

NEW JERSEY

ASBURY BICYCLE 1405 MAIN ASBURY, N. J.

ATLANTIC CITY HBY 1838 ATLANTIC ATLANTIC CITY, N. J.

BATTAGLIA TRAIN 399 AVE C. BAYONNE, N. J.

DOBBS, INC. 720 BROADWAY BAYONNE, N. J.

ROUND HSE HBY 943 BROADWAY BAYONNE, N. J.

AL LEVENDUSKY 832 BROADWAY BAYONNE, N. J.

N. JERSEY TRAIN CTR RT. 32 BEDMINSTER, N. J.

DeBACCO BROS. SPT 24 WASH. AVE BELLEVILLE 9, N. J.

THE CORNERS 116 SO. WASH. AVE. BERGENFIELD, N. J.

DANNYS HOBBY 179 N. WASH. AVE. BERGENFIELD, N. J.

HOBBY CTR. 7 PALISADE AVE. BERGENFIELD, N. J.

BROOKDALE CYCLE 1292 BROADFIELD BLOOMFIELD, N. J.

EVER READY SPT 392 BROAD BLOOMFIELD, N. J.

SIGNAL SHOP 162 N. PEARL BRIDGETON, N. J.

WALNUT ST. HBY 72nd & DODGE STS BRIDGETON, N. J.

FREEDMANS 228 HIGH ST. BURLINGTON, N. J.

HOBBYLAND 15 BROAD ST. BURLINGTON, N. J.

BUTLER NEWS CO. 105 MAIN BUTLER, N. J.

CALDWELL CYCL & HBY 391 BROADFIELD CALDWELL, N. J.

ROBIN HOOD ARCH 215 GLENRIDGE MONTCLAIR, N. J.

CAMDEN HBY DIS. 2752 FEDERAL CAMDEN, N. J.

SBARS 607 BROADWAY CAMDEN, N. J.

MERRIMAC HBY SHP 168 MAIN ST. CHATHAM, N. J.

ALAN F. SAVITT 90 MAIN ST. CLIFTON, N. J.

BILLS U FIX IT SHP 656 ALLWOOD CLIFTON, N. J.

THE SPORTSMAN SHP HWY 35 & 3D AVE. NEPTUNE CITY, N. J.

VINCES HBY HSE 555 LEXINGTON CLIFTON, N. J.

THE TOY CHEST 25 MARKET CLOSTER, N. J.

HYS HOBBIES COLUMBUS FARMERS COLUMBUS, N. J.

HARRIS HBY SHOP 32 E. BLACKWELL DOVER, N. J.

MODEL RAILROAD VAIL & MARKET DUNELLEN, N. J.

KOLKERS 1176 ELIZABETH ELIZABETH, N. J.

BELLER ELEC. TRAIN 700 COURT ST. ELIZABETH, N. J.

ENGLISHTOWN SPT 29 MAIN ST. ENGLISHTOWN, N. J.

ENGLISHTOWN SPORT 29 MAIN ST. ENGLISHTOWN, N. J.

AMBER CYCLE & HBY 1238 RIVER RD. FAIRLAWN, N. J.

HERBS STATIONERY 74 FAIRLAWN AVE. FAIRLAWN, N. J.

HUNTERDON SHP CTR FLEMINGTON, N. J.

DEES TRAIN TR 390 MAIN ST. HACKENSACK, N. J.

BOBS HBY SHOP 169 DIAMOND BRG HAWTHORNE, N. J.

INSTANT TV SERV. 206 N. MAIN ST. HAZLET, N. J.

HOBBY SHOP 760 SPRINGFIELD IRVINGTON, N. J.

EDDYS TOY & HBY 565 W. SIDE AVE. JERSEY CITY, N. J.

HOUSE BAZAAR SER. 299 CENTRAL JERSEY CITY, N. J.

WOHLRABS TV & HBY 444 CENTRAL JERSEY CITY, N. J.

KEARNEY HBY SHOP 311 KEARNEY KEARNEY, N. J.

SPECIAL SERV. OFFICE U.S. NAVAL AIR STA. LAKEHURST, N. J.

YANKS HBY SHOP 405 CLIFTON LAKEWOOD, N. J.

ROSEWOOD HBY 105 N. WOOD LINDEN, N. J.

DEE'S TRAIN CENTER 3356 KENNEDY BLVD. JERSEY CITY, N. J.

KNIGHTS 40 KAVRIK LITTLE FERRY, N. J.

LIVINGSTON SPT & HBY 18 E. MT. PLEASANT LIVINGSTON, N. J.

MORTONS SPT & HBY 93 MAIN MANASQUAN, N. J.

STOP LITE HBY 210 S. MAIN MANVILLE, N. J.

OSMUNS 176 MARLEWOOD MAPLEWOOD, N. J.

MUTUCHEN CENTER 400 MAIN METUCHEN, N. J.

BABYLAND JUVENILE 116 ESSEX MILLBURN, N. J.

KEREKS GIFT HBY 357 MILLBURN MILLBURN, N. J.

MILLBURN TY & TRN 119 W. MAIN MILLBURN, N. J.

HOBBY CENTER 517 N. 7th ST. MILLVILLE, N. J.

ROBIN HOOD ARCH 215 GLENRIDGE MONTCLAIR, N. J.

ROY'S HBY & TOY 446 SPRINGFIELD SUMMIT, N. J.

AMBER CYCLE & HBY 42 CEDAR LANE TEANECK, N. J.

HOBBY LOBBY RT. 37, BAYSHORE TOMS RIVER, N. J.

SPORT HBY SHOP 8 WATER ST. TOMS RIVER, N. J.

AMERICAN RADIO CO. 25 E. HANOVER TRENTON, N. J.

SCHRADERS 151 EWINGVILLE TRENTON, N. J.

SCHROEDERS PHOTO 151 EWINGVILLE TRENTON, N. J.

DEMORIS HBY CTR 72 S. OLDEN TRENTON, N. J.

TRENTON HBY CTR 237 E. STATE TRENTON, N. J.

PIED PIPER JUV STR 1060 STUYVESANT UNION, N. J.

MT. PET & HBY SHOP 640 VALLEY UPPER MONTCLAIR, N. J.

KOTOK HDWE 717 LANDIS AVE. VINELAND, N. J.

W. WYCKOFF 310 GRAPE VINELAND, N. J.

BUY RITE 1166 HAMBURG TPKE WAYNE, N. J.

SATTLER HBY 14 HADDON AVE. WESTMONT, N. J.

SPEED AUTO STORES 6126 BERGENLINE W. NEW YORK, N. J.

WESTWOOD PHOTO SER. WESTWOOD & CENTER WESTWOOD, N. J.

WALLY'S HBY SHOP RT. 101 WHITEHOUSE, N. J.

PILGERS SPORT STR 14 N. MAIN WILWOOD, N. J.

HOBBY WORLD 204 W. WYCKOFF, N. J.

NASSAU HOBBY 142 NASSAU ST. PRINCETON, N. J.

MCLAUGHLINS 628 BAY AVE. PT. PLEASANT, N. J.

SPORT & HBY SHOP 705 ARNOLD PT. PLEASANT, N. J.

MARCO PLAYMART 574 TURNPIKE PRINCETON PLAINS, N. J.

RADIO CENTER 14 WITHERSPOON PRINCETON, N. J.

RAHWAY HBY SHOP 1645 IRVING ST. RAHWAY, N. J.

SCHATZMANS 1563 MAIN RAHWAY, N. J.

HIWAY HBY HOUSE ROUTE 17 RAMSEY, N. J.

BELDER VARIETY, INC. 1041 SOUTH AVE. PLAINFIELD, N. J.

RIDGEWOOD HBY 195 RIDGEWOOD RIDGEWOOD, N. J.

RIDGEWOOD JUV FURN. 185 E. RIDGEWOOD RIDGEWOOD, N. J.

RIDGEWOOD TRN & HBY 19 W. RIDGEWOOD RIDGEWOOD, N. J.

PAULS HBY SPORT 305 UNION RUTHERFORD, N. J.

J & A HOBBY WORLD 102 RT. 46 SADDLE BROOK, N. J.

TAGG ALONG HBY 28th & 5 SHIPS BOTTOM, N. J.

VARIETY GIFT SHOP 715 MAIN SINGAC, N. J.

SOMERS POINT HDWE 814-16 SHORE RD. SOMERS POINT, N. J.

BOBS HBY CTR 119 W. MAIN SOMERVILLE, N. J.

VILLAGE HOBBY 14 SLOAN S. ORANGE, N. J.

KAYS STATIONERY 279 MORRIS SPRINGFIELD, N. J.

ROY'S HBY & TOY 446 SPRINGFIELD SUMMIT, N. J.

AMBER CYCLE & HBY 42 CEDAR LANE TEANECK, N. J.

HOBBY LOBBY RT. 37, BAYSHORE TOMS RIVER, N. J.

SPORT HBY SHOP 8 WATER ST. TOMS RIVER, N. J.

AMERICAN RADIO CO. 25 E. HANOVER TRENTON, N. J.

SCHRADERS 151 EWINGVILLE TRENTON, N. J.

SCHROEDERS PHOTO 151 EWINGVILLE TRENTON, N. J.

DEMORIS HBY CTR 72 S. OLDEN TRENTON, N. J.

TRENTON HBY CTR 237 E. STATE TRENTON, N. J.

PIED PIPER JUV STR 1060 STUYVESANT UNION, N. J.

MT. PET & HBY SHOP 640 VALLEY UPPER MONTCLAIR, N. J.

KOTOK HDWE 717 LANDIS AVE. VINELAND, N. J.

W. WYCKOFF 310 GRAPE VINELAND, N. J.

BUY RITE 1166 HAMBURG TPKE WAYNE, N. J.

SATTLER HBY 14 HADDON AVE. WESTMONT, N. J.

SPEED AUTO STORES 6126 BERGENLINE W. NEW YORK, N. J.

WESTWOOD PHOTO SER. WESTWOOD & CENTER WESTWOOD, N. J.

WALLY'S HBY SHOP RT. 101 WHITEHOUSE, N. J.

PILGERS SPORT STR 14 N. MAIN WILWOOD, N. J.

HOBBY WORLD 204 W. WYCKOFF, N. J.

NEW MEXICO

DUKE CITY HBYS 2715 SAN PEDRO ALBUQUERQUE, N. M.

YANVS HBY HOUSE 8305 MENOUE N E ALBUQUERQUE, N. M.

CLOVIS HBY HOUSE 1314 MAIN ST. CLOVIS, N. M.

HOBBIS HBY LOBBY 104 E. BROADWAY HOBBS, N. M.

BILL MAYNE TOYS 704 N. TURNER HOBBS, N. M.

WESTERN HBY SHOP 410 E. LOHMAN LAS CRUCES, N. M.

JERRY'S HOBBIES 818 S. SOLANO LAS CRUCES, N. M.

SPECIALTY SHOP 807 1075 COMM CT LOS ALAMOS, N. M.

NEW YORK

COLVIN SPT & HBY 69 COLVIN AVE. ALBANY, N. Y.

HOBBY TOWN 201 CENTRAL ALBANY, N. Y.

PALACE HBY CTR 27 CLINTON ALBANY, N. Y.

SNOWDONS FIRESTONE 319 N. MAIN ALBION, N. Y.

ROSIER HDWE 295 MAIN ARCADE, N. Y.

HESCO HBYS INC. 1515 5th ST. ASTORIA, N. Y.

MURRAYS TOY & HBY 25 12 BROADWAY ASTORIA, N. Y.

LEOS TOY CTR 115 GENESSEE ST. AUBURN, N. Y.

BABYLON REC. 226 W. MAIN BUFFALO, N. Y.

RODGERS HBY CTR 207 N. GRAND BLDWIN, N. Y.

BUDDYS RNDHSE 63 MANHATTAN BATAVIA, N. Y.

DAVIS WHEEL GDS 8 CENTER ST. BATAVIA, N. Y.

HOBBY CTR 145 W. GENESSEE BUFFALO, N. Y.

TOY FAIR SUNRISE HWY BAYSHORE, N. Y.

BAYSIDE CYCLE 33013 FRANCIS LEW BAYSIDE, N. Y.

TOY CITY 214 27th NO. BLVD. BAYSIDE, N. Y.

RUTCO 455 1st ST. AVE. BELLMEAD, N. Y.

ARCH WAY HBY 339 MAIN BINGHAMTON, N. Y.

KERNS HBYS 12 COURT ST. BINGHAMTON, N. Y.

BLASDELL HBY 90 MARLOWE BLVD. ELIZABETH, N. Y.

ARROW CYCLE HBY 4055 WHITE PLN RD. BRONX 66, N. Y.

BRONX ATLAS 412 E. TREMONT BRONX, N. Y.

YAN CORTLANDT HBY 6031 BROADWAY BRONX 71, N. Y.

BROWNS HBY CTR 2531 BROADWAY BRONX, N. Y.

FORDHAM HBY 470 E. FORDHAM BRONX, N. Y.

J. R. HOBBY 4008 E. TREMONT BRONX, N. Y.

PARKCHESTER CYCLE 1354 WHITE PLNS BRONX, N. Y.

PELHAM HBY & CYCLE 1461 PARKFIELD BRONX, N. Y.

WALTON STORES 2561 WEBSTER BRONX 58, N. Y.

BRONX HOBBY, INC. 1336 JEROME AVE. BRONX 52, N. Y.

HYDE PARK HBY 1324 METROPOLITAN BRONX, N. Y.

ARTISAN HBYCRAFT 2204 4th ST. BROOKLYN, N. Y.

BRICKER & ANDES 290 ATLANTIC BROOKLYN, N. Y.

FTWAY CAMERA SHOP 6718 FT. HAMILTON BROOKLYN, N. Y.

GARDEN CARD & HBY 937 E. 108th ST. BROOKLYN, N. Y.

NORMANS REPAIR 244 KINGS HWY BROOKLYN, N. Y.

REX STORES 18th AVE & 86th ST. BROOKLYN, N. Y.

SCOTTYS 3042 AVE U BROOKLYN, N. Y.

SEAVIEW RECORD 1965 ROCKAWAY BROOKLYN, N. Y.

SLAVIN CAM SHOP 309A UTICA BROOKLYN, N. Y.

SPERA HOBBIES 480 PROSPECT BROOKLYN, N. Y.

STANLEYS FISHING 4914 FOURTH AVE. BROOKLYN, N. Y.

THUNDERBIRD HBY 225 5th AVE. BROOKLYN, N. Y.

ALBANY CIRCLE 5204 5th AVE. BROOKLYN, N. Y.

BROADWAY HOBBYCRA 1638 BROADWAY BROOKLYN, N. Y.

FEDDERS 4222 8th AVE. BROOKLYN, N. Y.

BEACON HOBBIES 15 CHURCH ST. BUFFALO, N. Y.

FIELDS HBY CTR 3184 BAILEY BUFFALO, N. Y.

HOBBY HUT 3680 HARLEM BUFFALO 15, N. Y.

MODEL HBY 20 W. MAIN BUFFALO, N. Y.

QUICK TRIP S & S 715 W. WOOD BUFFALO, N. Y.

RECORDS UNLTD 1234 ABBOTT BUFFALO, N. Y.

RIVERSIDE HBYS 237 ONTARIO BUFFALO, N. Y.

H. E. RUTH HBYS 145 W. GENESSEE BUFFALO, N. Y.

BRONX HOBBY, INC. 1336 JEROME AVE. BRONX 52, N. Y.

SPOONLEY 37 CHOATE BUFFALO 20, N. Y.

HAMILTON SHOP 28 MAIN CALEDONIA, N. Y.

SAM STANNARD CAMBRIDGE, N. Y.

HOBBY CRAFT 616 S. MAIN CANADAIGUA, N. Y.

FLETCHERS HBY MDLE CNTRY RD CENTEREACH, N. Y.

CENTRAL HBY SHOP 72 CARELTON CENTRAL ISLIP, N. Y.

CORNING HBY CTR 59 E. MARKET CORNING, N. Y.

WOLCOTTS SPTG GDS 34 W. MARKET CORNING, N. Y.

ROMANOS HBY SHOP PORT WATSON ST. CORTLAND, N. Y.

ELEC. APPL. SERV. 115 MAIN DANSVILLE, N. Y.

HILLS NEWS 628 MAIN ST. E. AURORA, N. Y.

BOBS HBY SHOP 360 LARKFIELD E. NORTHPORT, N. Y.

HOBBYLAND 7 HEWLETT E. NORTHPORT, N. Y.

LEES HOBBY 3018 JERICHO TPK E. NORTHPORT, N. Y.

CLAPPS HOBBIES LANGDON PLAZA ELMIRA, N. Y.

WHITES TOYLAND 206 PENNA. ELMIRA, N. Y.

UDELS HBY SHOP 260 MAIN FARMINGDALE, N. Y.

FREDERICK E. BALL P34 WYCKOFF FARNHAM, N. Y.

AQUA PET HBY DEN 138 18A NRTHN BL FLUSHING, N. Y.

BAYSIDE CYCLE 33 13 FRANCIS LEW FLUSHING, N. Y.

BERMOR CO. 72 02 MAIN FLUSHING 67, N. Y.

CASEY'S CHILDREN CTR. 523 TITUS AVE. ROCHESTER 17, N. Y.

FRANKLIN HBY 81 FRANKLIN FRANKLIN SQ., N. Y.

THE HOBBY SHOP 224 W. MAIN FREDONIA, N. Y.

NASSAU HOBBY 35 CHURCH FREEPORT, N. Y.

B & T SPORTS SHOP 54 S. FIRST ST. FULTON, N. Y.

TERVOS 14 NASSAU GARDEN CITY, N. Y.

RAYS BIKE & KEY 444 EXCHANGE GENEVA, N. Y.

CRAFT CENTER 20 SCITUATE GLEN COVE, N. Y.

COLONY CARD SHP 209 FOREST GLEN COVE, N. Y.

HBY CRAFT CTR 18 SARATOGA SO. GLEN FALLS, N. Y.

STRAUCH LTHCRAFT 24 SANFORD ST. GLEN FALLS, N. Y.

HOBBY CENTER 15 CHURCH ST. GLOVERSVILLE, N. Y.

STOWELLS, INC. 137 N. MAIN GLOVERSVILLE, N. Y.

J. P. FLIEGEL CO. 4 FOREST ST. GLOVERSVILLE, N. Y.

JOE FIX IT TOY 20 W. MAIN GOSHEN, N. Y.

EVERBEST DIST. 481 MIDDLE NK RD GREAT NECK, N. Y.

JAYS OF NO. SHORE 74 MIDDLE NECK RD. GREAT NECK, N. Y.

NEALS HBY CTR 138 MIDDLENECK RD GREAT NECK, N. Y.

SPORTING GDS CTR HAMBURG SHP CTR HAMBURG, N. Y.

PEEIFER SPT GDS. HAMBURG SHP PLZ HAMBURG, N. Y.

SIMKINS 37 CHOATE HAVERTRAW, N. Y.

FIVETOWNS HBY & ART 1189 BROADWAY HEWLETT, N. Y.

THRIFT CITY 444 S. HORTERBAY HICKSVILLE, N. Y.

JACKS SPT SHOP 8 CENTER HORNELLS, N. Y.

HORSEHEAD HBY 202 GARDNER HORSEHEAD, N. Y.

THE CABOOSE 219 WALL ST. HUNTINGTON, L.I., N. Y.

THE HOBBY DEN 306 E. STATE ITHACA, N. Y.

ITHACA SPT GDS. 420 EDDY ITHACA, N. Y.

CENTER CYL & HBY 75 14 ROOSEVELT JACKSON HTS, N. Y.

T. R. HERMAN CO. 90 22 SUTPHIN JAMAICA, N. Y.

JAMESTOWN COIN 25 N. MAIN JAMESTOWN, N. Y.

PERRYS MODEL 3044 DELAWARE JAMESTOWN, N. Y.

THE TOY SHOP 211 PINE ST. JAMESTOWN, N. Y.

BURDS HBY HSE 3044 DELAWARE KENMORE 17, N. Y.

OTTOS 650 BROADWAY KINGSTON, N. Y.

RIDGE HBY CTR 517 RIDGE RD. LACKAWANNA, N. Y.

PAULDINGS CYCLE 102 BOSTON POST RD. LARCHMONT, N. Y.

BARNETTS LATHAM SHP CTR LATHAM, N. Y.

VICS HBY SHOP 224 16 MERRICK LAURELTON, N. Y.

FRANKLIN CAM 3266 HEMPSTEAD LEVITTOWN, N. Y.

SUPER TOY DISC. 37 15 HEMP TRKE LEVITTOWN, N. Y.

UDELS SPTS CTR 149 N. WELWOOD LINDENHURST, N. Y.

L. B. STAMP & HBY 272 W. PARK LONG BEACH, N. Y.

CENTER HBY SHOP 42 13 QUEENS BLVD L. I. CITY 4, N. Y.

TRIANGLE MODEL 43 05 BROADWAY L. I. CITY 3, N. Y.

TOMS SPT & HBY SHP 26 CANAL LYONS, N. Y.

WESTERN AUTO ASSOC. MALONE, N. Y.

RAYS CAMERA SHOP 304 HEMPSTEAD AVE. MALVERNE, N. Y.

BOBS HOBBY SHOP 123 MAMARONECK AVE MAMARONECK, N. Y.

HOBBY HORSE 1370 N. BLVD. MANHASSET, N. Y.

D & J BIKE & HBY 1030 PARK BLVD MASSAPEQUA PK, N. Y.

TWO GUYS FROM MAS. 1000 SUNRISE MASSAPEQUA, N. Y.

WHITE TOY CO. 1100 SUNRISE HWY MASSAPEQUA, N. Y.

MASPEPH BIRD STORE 71 111 GRAND MASPETH 78, N. Y.

DANS SPT SHOP 7 WATER MASSENA, N. Y.

A. M. BOCCAMAZZA 6751 78th ST. MIDDLE VLG 79, N. Y.

ELIOT CYCLE SHOP 82-16A ELIOT AVE. MIDDLE VILLAGE, N. Y.

PLAYMATES, INC. 82 88 S. WOODER MT. KISCO, N. Y.

MILLERS JUV. FURN. 200 MAIN ST. MT. KISCO, N. Y.

MODELAIRE 36 WEST 1st ST. MT. VERNON, N. Y.

PLAZA HOBBY SHOP NEWARK SHP PLZ NEWARK, N. Y.

CONOVERS 90 BROADWAY NEWBURGH, N. Y.

LORCH SPTG GDS 240 BROADWAY NEWBURGH, N. Y.

STEVENS BLUME SPT 202 BROADWAY NEWBURGH, N. Y.

PLAZA TOY SHOP 8 CENTER NEW HARTFORD, N. Y.

PLAZA TOY SHOP 8 CENTER ST. NEW HARTFORD, N. Y.

AMER. HBY CTR. 145 W. 22nd ST. NEW YORK 11, N. Y.

HOBBY MART 625 EIGHTH AVE. NEW YORK, N. Y.

HOUSTON TRN & HBY 55 E. HOUSTON NEW YORK, N. Y.

JULIES TRN & TOY 40 E. 23rd ST. NEW YORK, N. Y.

O. KAMMERMAN & SON 58 AVE A NEW YORK, N. Y.

MODEL RR EQUIP 23 45th ST. NEW YORK, N. Y.

REISS BROS. 54 E. 10th ST. NEW YORK, N. Y.

SPIEGEL NOVELTY 105 NASSAU NEW YORK, N. Y.

ACE HBY 1801 PIERCE NIAGARA FALLS, N. Y.

DICKS HBY & CRFTS 521 19th ST. NIAGARA FALLS, N. Y.

SEE BOTTOM OF PAGE 31 FOR LATEST SERVICE STATION ADDITIONS IN YOUR STATE.

PINE LEES AUTO SUP MIL PINE FALLS NIAGARA FALLS, N. Y.	SPTS & CAM. SHOP 1204 EASTERN AVE. SCHENECTADY, N. Y.	WILLIS CRAFT SHOP 332 HILLSIDE WILLISTON PK, N. Y.	PAULS HBY & BIKE 714 WAUGHTON ST. WINSTON SALEM, N. C.	ROGERS TOYS & HBY 265 SWIFTON CINN. 37, OHIO	RIKE KUMLER 2nd & MAIN DAYTON, OHIO	MENTOR HDWE & APPL. 8701 MENTOR MENTOR, OHIO	TRUMBULL CAM & HBY TRUMBULL PLAZA WARREN, OHIO
TOWN HBY 4424 MILITARY NIAGARA FALLS, N. Y.	LEISURE CRAFTS 242 STATE ST. SCHENECTADY, N. Y.	JASONS TOYS 9009 JAMAICA WOODHAVEN 21, N. Y.	NORTH DAKOTA SILOUS SPORTING CO. 114-5th ST. BISMARCK, N. D.	SWALLENS 3700 RED BANK CINCINNATI, OHIO	HOBBY DEN 302 CLINTON DEFIANCE, OHIO	MT. HEALTHY TOY 17514 HAMILTON MT. HEALTHY 31, OHIO	BOYLAN HBY SHOP 118 N. FAYETTE WASH CH, OHIO
SCHOENFELDT 307 SCHNECK N. TONAWANDA, N. Y.	4 STAR HOBBY CTR. 120 STATE ST. SCHENECTADY, N. Y.	HANDY DAN 262 RIVERDALE YONKERS, N. Y.	BENNERS, INC. 316 KITTSON GRAND FKS, N. D.	TOY HOUSE 18125 EUCLID CINCINNATI, OHIO	ADAMS HBY SHOP 24 SANDUSK DELAWARE, OHIO	JOHNS HBY CTR 23 W. VINE MT. VERNON, OHIO	OSBORNE DRUG STR 117 S. FULTON ST. WAUSEON, OHIO
LUANNE TOYS OAKDALE SHP PLZ OAKDALE, N. Y.	KOPLOWS SALES 416 SARATOGA SCOTIA 2, N. Y.	LEWS AUTO SUP 25 N. BROADWAY YONKERS, N. Y.	GOY CHEST 15 N. 3rd ST. GRAND FKS, N. D.	WORLD ENGINES 8206 BLUE ASH CINCINNATI, OHIO	SCHROCKS HBY 177 MIR LANE DOVER, OHIO	THE FUN SHOP 33 S. MAIN NEW LONDON, OHIO	MACIS COIN & HBY 20 NORTH ST. W. CARROLLTON, OHIO
JOANS HBY MART 2798 LONG BEACH OCEANSIDE, N. Y.	LEISURE CRAFTS 262 SARATOGA SCOTIA, N. Y.	YONKERS HOBBIES 444 S. BROADWAY YONKERS, N. Y.	OHIO AKRON HBY CTR 17 S. MAIN AKRON 8, OHIO	HELENE MENNINGER RD. 7819 MONTGOMERY CINCINNATI, OHIO	SNYDERS TUSCARAWAS & 4th DOVER, OHIO	DALES HBYCRAFT 314 E. HIGH NEW PHILA., OHIO	SAYLER SERV & SUP 29025 EUCLID WICKLIFFE, OHIO
KOPPPELLS MODEL 215 N. UNION OLEAN, N. Y.	SPORTS & CRAFT 104 MOHAWK SCOTIA 2, N. Y.	AKRON HBY CTR 17 S. MAIN AKRON 8, OHIO	DICKS BIKE & HBY 1760 BROWN AKRON 19, OHIO	ALS HBY & TOY 4028 E. 71st ST. CLEVELAND, OHIO	BURBICKS HDWE 515 BROADWAY E. LIVERPOOL, OHIO	LA FOUNTAINES 126 E. HIGH NEW PHILA., OHIO	BOYDS SPORT GDS 38566 LK SHR WILLOUGHBY, OHIO
BILLS SPORT & HBY 11 WALL ST. ONEONTA, N. Y.	SIDNEY PAINT CENTER 78 MAIN ST. SIDNEY, N. Y.	NORTH CAROLINA A N L HOBBICRAFT 115 W. 1st ST. ASHEVILLE, N. C.	GLENS TRAIN SHP 587 GRANT AKRON 11, OHIO	BARON HBY SHOP 898 E. 22nd ST. CLEVELAND 23, OHIO	BARONS HBY SHOP 398 E. 22nd S. EUCLID, OHIO	BILLS HBY HAVEN PLAZA SHP CTR NEWARK, OHIO	WILLO HDWE 36212 EUCLID WILLOUGHBY, OHIO
BENS STATIONERY 189 MAIN OSSINGIN, N. Y.	GRUBES CYCLE 3100 MILTON SOLVAY, N. Y.	FRENCHS VARIETY 771-73 HAYWOOD ASHEVILLE, N. C.	HOUSE OF TIME 2517 MOGADORE AKRON 12, OHIO	CLEVE HBY SUP. 4526 LORAN CLEVELAND, OHIO	HILLS APL & HBY 213 HIGH FAIRPORT HBR, OHIO	LENZO STUDIO 116 MAIN NEWCOMRSTWN, OHIO	KLUG SERV. CTR 258 MAIN SHR GATE WILLOWICK, OHIO
TIP TOP 31 SPRING OSSINGIN, N. Y.	BOB & LEES 111 05 LEFFERTS SO OZONE PK, N. Y.	HOBBY HOUSE 72 MERRIMON ASHEVILLE, N. C.	LAKE HBY CAMERA 1825 MANCHESTER AKRON 19, OHIO	CLEVE HBY SUP 5238 RIDGE CLEVELAND, OHIO	FINDLAY HBY SHOP 115 S. MAIN FINDLAY, OHIO	KINGS HBY CTR 1140 SO. MAIN N. CANTON, OHIO	WILMINGTON PAINT 74 N. SOUTH ST. WILMINGTON, OHIO
AERO SPT GDS 12 E. BRIDGE OSWEGO, N. Y.	HOBBY LAND 93 MAIN ST. SOUTHAMPTON LI, N. Y.	WESTGATE TOY HBY WESTGATE SHP CTR ASHEVILLE, N. C.	M. ONEIL CO. 226 S. MAIN AKRON, OHIO	EUCLID GREEN HDWE 1534 EUCLID CLEVELAND, OHIO	J & J GIFT SHOP 121 E. TIFFIN ST. FOSTORIA, OHIO	ENCHANTED TOY SHP 23812 LORAIN N. OLMSTED, OHIO	TREASURE HOUSE 236 W. LIBERTY WOOSTER, OHIO
JIMS PHOTO & HBY 309 E. MAIN PALMYRA, N. Y.	KENN'S HBY TOWN 562 MIDDLE NECK RD. GREAT NECK, N. Y.	RONNIE HBY SHOP 115 WEBB BURLINGTON, N. C.	ALLIANCE HDWE 318 E. MAIN ALLIANCE, OHIO	HOBBY FAIR 21472 LORAIN CLEVE 26, OHIO	GAHANNA HBY SHOP 245 GRANVILLE GAHANNA, OHIO	THE SPORT SHOP 16 S. MAIN OBERLIN, OHIO	PIERCES SPORT SHP 143 E. LIBERTY ST. WOOSTER, OHIO
PATCHOGUE TOY COR. MEDFORD AVE. & SUN PATCHOGUE, N. Y.	SHERWOOD FOREST 487 JERICHO SYOSSET, N. Y.	BILLY ARTHUR INC. EASTGATE SHP CTR CHAPEL HILL, N. C.	MOORES 1150 E. STATE ALLIANCE, OHIO	HOBBY HOUSE 800 HURON RD CLEVELAND, OHIO	HBY HSE GALION 112 S. BOSTON GALION, OHIO	KICK ZARLES ON THE SQUARE ORRVILLE, OHIO	AMER HBY SHOP 1326 MARKET YOUNGSTOWN, OHIO
PARK STATIONERY 10 SO. MAIN PEARL RIVER, N. Y.	SYOSSET CAMERA 34 OLD SPRG RD SYOSSET, N. Y.	JOHNNIES HBY HSE 900 KINGS DR. CHARLOTTE, N. C.	BOBS HBY & GIFT SHP 294 LURCH AMHERST, OHIO	HOBBYVILLE 1011 LORAIN CLEVELAND, OHIO	WESTRICH STORE 203-05 N. MAIN ST. DELPHOS, OHIO	FRIZZELS TOYLAND 192 MAIN PAINESVILLE, OHIO	BOARDMAN HBY & CYL 5534 MAHONING YOUNGSTOWN 9, OHIO
SOKSELS HBY SHOP 1059 MAIN PEEKSKILL, N. Y.	ED GLUTH HBYS 224 S. SALINA SYRACUSE 2, N. Y.	HIPP McBRIDE CO. 16 E. DEPOT CONCORD, N. C.	GLASGOS HBY SHOP 17 E. MAIN ASHLAND, OHIO	JAYE & JAYE 16360 EUCLID CLEVELAND, OHIO	BRUCK RADIO & HBY 201 WALNUT HAMILTON, OHIO	HAROLDS TOY & HBY 1519 MENTOR PAINESVILLE, OHIO	BOARDMAN HBY 7411 MARKET YOUNGSTOWN, OHIO
THE WORKSHOP 122 MAIN PENN YAN, N. Y.	MODEL RAILROAD 219 E. FAYETTE SYRACUSE, N. Y.	E. J. MAY HOBBIES 210 CORCORAN ST. DURHAM, N. C.	ARTLETONS HM & AUT 451 LAKE ASHTABULA, OHIO	NOBBY HBY SHOP 10310 UNION CLEVELAND, OHIO	DONS HBY SHOP 125 MAIN HAMILTON, OHIO	HOBBY LOBBY 1420 MENTOR PAINESVILLE, OHIO	L & R SPT HBY 287 MAHONING YOUNGSTOWN, OHIO
PAVONES SHOE HOSP 20 MARGARET PLATTSBURG, N. Y.	SAMS HBY & TOY 358 S. SALINA SYRACUSE, N. Y.	SPEAS HM & AUTO SUP 103 E. MAIN ELKIN, N. C.	BARBERTON HBY SHP 190 2nd ST. BARBERTON, OHIO	REDS HBYCRFT 7804 ST. CLAIR CLEVE 10, OHIO	FOTO CRAFT 154 HIGH HAMILTON, OHIO	HUDGEONS 7661 W. RIDGWOOD PARMA, OHIO	GM McKEVELY 210 W. FEDERAL YOUNGSTOWN, OHIO
PT. HBY SHOP 126 MAIN PT. JEFFERSON, N. Y.	FRANKIES BIKE & HBY 479 OLIVER N. TONAWANDA, N. Y.	MARTYS RECORD HBY 24 BATAVIA, OHIO	MARTYS RECORD HBY 24 BATAVIA, OHIO	ROOTS HBY SHOP 309 S. 3rd MORTON, OHIO	MORTS AUTO SUP 309 S. 3rd MORTON, OHIO	ORR TOY & NOVELTY 219 NO. MAIN PIQUA, OHIO	DUNNS MODEL TRN ROUTE 4 ZANESVILLE, OHIO
LACINE HOBBIES 14-16 JERSEY PORT JERVIS, N. Y.	THE TONAWANDA HBY 23 YOUNG ST TONAWANDA, N. Y.	JIMS MODELS 115 W. MAIN BELLERUE, OHIO	GORMANS 44 FRONT BEREA, OHIO	SPARKS HBY & GIFT 4136 E. 131st ST. CLEVELAND 5, OHIO	SPARKS HBY & GIFT 4136 E. 131st ST. CLEVELAND 5, OHIO	SMITH HBY 812 6th ST. PORTSMOUTH, OHIO	TOYLAND CO. FAIR SHP CTR ZANESVILLE, OHIO
JUMBLE HOBBIES 135 MAIN ST. PORT WASHINGTON, N. Y.	LUTHER HBY SHOP 2763 EGGERT TONAWANDA, N. Y.	BEASLEY DRUG MAIN ST. FOUNTAIN, N. C.	JOHNS TOY & HBY 220 W. MAIN GASTONIA, N. C.	KUEHNE RADIO 714 S. LYNN ST. TROY, N. Y.	SPTS & CRAFTS 2086 E. TAYLOR CLEVE HTS, OHIO	COL. RUPERT SALES 232 W. MAIN STROOP RAVENNA, OHIO	OKLAHOMA TOYLAND 421 12th NW ARDMORE, OKLA.
COTTAGE HBY MART 6 DELAVIA POUGHKEEPSIE, N. Y.	O. CONNORS 24 N. NIAGARA TONAWANDA, N. Y.	JOHNS TOY & HBY 220 W. MAIN GASTONIA, N. C.	MUSIC & SPORTS 202 E. WALNUT GOLDSBORO, N. C.	BONENPAIN STR 132 N. SANDUSKY BUCYRUS, OHIO	AAA HBY DEN 3764 TWIN & CNTRY COLUMBUS, OHIO	V & F HOBBIES CNTRY CLUB LANE SALEM, OHIO	WEBBS PAINT & OFF. 30 N. WASH ARDMORE, OKLA.
LEN MELVADOS 511 MAIN POUGHKEEPSIE, N. Y.	FRENCHS 714 ST. TROY, N. Y.	FRIENDLY TOY & HBY FRIENDLY YHP CTR GREENSBORO, N. C.	GARLOCK & GUEST 3700 S. CLEVELAND CANTON 6, OHIO	SCHROCKS COINS 1416 WHIPPE CANTON, OHIO	HBY & CYCLE 235 S. MAIN COLUMBIANA, OHIO	HOBBYCRAFTS 205 E. STATE SALEM, OHIO	HARLEYS 111 E. 2nd ST. BARTLESVILLE, OKLA.
ARTCRAFT HBY SHOP 25609 UNION TPKE QUEENS, N. Y.	NASH HBY SHOP 470 PAWLING TROY, N. Y.	WARRENS TOYLAND 2168 LAWDALE GREENSBORO, N. C.	SCHROCKS COINS 1416 WHIPPE CANTON, OHIO	ELMERS - 2577 CLEVELAND CANTON, OHIO	WINGS HBY SHOP 17114 DETROIT AVE. LAKWOOD 7, OHIO	THE CRAFT SHOP 225 W. WATER SANDUSKY, OHIO	PATONS VARIETY 204 N. MAIN BRISTOW, OKLA.
BROWN'S MDL TRAIN TANNERS NECK LANE WESTHAMPTON, N. Y.	NASH HBY SHOP 88 CONGRESS TROY, N. Y.	WHITESIDE HBY 202 N. MAIN HENDERSONVILLE N. C.	CATAWA JEWELERS 115 MAIN AVE. SW HICKORY, N. C.	SHROCKS HBY MEYER LK PLAZA CANTON, OHIO	BASHFORDS 12-16 S. BGDY LEBANON, OHIO	AMER. FEED HDWE 1101 N. COLE LIMA, OHIO	ENID NEWS & STAT 216 W. RANDOLPH ENID, OKLA.
FOUNT OF YOUTH QUOQUE, N. Y.	A & J HBY HOUSE 19 AUBURN UTICA, N. Y.	SHETLON HBYS 3010 MARTINDALE CANTON, OHIO	BICYCLE TOY & HBY 504 N. MAIN HIGH POINT, N. C.	FRANK P. HALL 15 HIGH COLUM. 15, OHIO	MOLDERS WHEEL SER. EUREKA CENT LIMA, OHIO	SNYDER TV & HBY 972 SELMA SPRINGFIELD, OHIO	LYONS TOY & HBY 612 D. ST. LAWTON, OKLA.
KID STUFF, INC. 209 E. MAIN RIVERHEAD, N. Y.	THE GIFT SHOP PALM THEATRE ONEONTA, N. Y.	SHROCKS HBY MEYER LK PLAZA CANTON, OHIO	EBEY'S MODEL SHOP 1741 ROOSEVELT AVE. CANTON, OHIO	HOBBYLAND 4612 E. MAIN COLUM. 13, OHIO	BOWERS 436 N. WALNUT LOGAN, OHIO	MOSEBLACKS TOY & HBY 301 S. FOURTH STUEBVILLE, OHIO	BIG TOP PLYHSE 7421 NORTH MAY OKLA CITY, OKLA.
KELLY ELEC. SUP. 112 10 LIBERTY RICHMOND HILL, N. Y.	BARBEN & FARMER 170 ASSESSORS WATERTOWN, N. Y.	MANNS DRUG 1910 N. MAIN HIGH POINT, N. C.	GRACELAND HBYLAND 140 GRACELAND COLUMBUS, OHIO	MACS TRAIN REP U S 27 22 COLUM. 4, OHIO	BWAY HBY & GIFT 3103 BROADWAY LORAIN, OHIO	FUN HOUSE 5614 SECOR TOLEDO 13, OHIO	CAMPBELLS HBY HSE 1931 PINE ST. OKLA CITY, OKLA.
McCURDY & CO. DEPT. 60 ROCHESTER, N. Y.	VIK'S HOBBY CTR. 1649 RALPH AVE. BROOKLYN 36, N. Y.	SAUNDERS HBY & TOY COLLEGE VLG SHP CTR HIGH POINT, N. C.	BEYER CRAFT U S 27 22 CHAGRIN FLS, OHIO	NWORBS ELEC. TRN 3243 WHITEHEAD COLUM. 4, OHIO	ALBERTS 239 N. WASH. TIFFIN, OHIO	HARTMAN HBY LBY 2154 W. CENTRAL LOUISVILLE, OHIO	HALES HBY TOYS 9005 N. PENN OKLA CITY, OKLA.
EDMUNDS HBY SHOP 337 GENEESE ROCHESTER, N. Y.	BILLS HOBBYS 511 N. FRANKLIN WATKINS GLEN, N. Y.	WESTERN AUTO 121 S. MAIN LENOIR, N. C.	THE TOY CRIB 11 TOY FRANKLIN CHAGRIN FLS, OHIO	NWORBS ELEC. TRN 1889 SULLIVAN COLUMBUS, OHIO	STEMO 330 ASHLAND MANSFIELD, OHIO	REDFIN BIG TOP 933 SW 44th OKLA CITY, OKLA.	SCHMITTS HBY 750 N. MAY OKLA CITY, OKLA.
CARLS HBY HOUSE 1310 N. CLINTON ROCHESTER 21, N. Y.	SUPERIOR PAINTS 332 BROAD WAVERLY, N. Y.	BRIGGS HBY TOY S. MAIN LEXINGTON, N. C.	PEOPLES HDWE 15 E. MAIN CHILLICOTHE, OHIO	SHUTTZIES HBY DEN 3893 GREAT S CT COLUMBUS, OHIO	TOYLAND 1209 W. PARK MANSFIELD, OHIO	REDING BIG TOP 933 SW 44th OKLA CITY, OKLA.	STANDARD CYCLE 609 NW 2nd OKLA CITY, OKLA.
HERMANS HBY SHOP 1506 DEWEY ROCHESTER, N. Y.	JOHN E. BUSH SPTG 169 N. MAIN WELLSVILLE, N. Y.	HOBBY & SPT CTR 210 N. STERLING MORGANTOWN, N. C.	WESTERN AUTO 121 S. MAIN LENOIR, N. C.	STRETE HBYS 3655 SULLIVAN COLUM. 4, OHIO	HOBBY HSE, INC. 5240 WARNVL CTR MAPLE HTS 37, OHIO	LESTERS BIKE SHOP 2720 SYLVANIA TOLEDO 13, OHIO	TOYS FOR BIG BOYS 1138 NE 36th OKLA CITY, OKLA.
MONROE TOY CO. 495 MONROE ROCHESTER, N. Y.	COHENS TOYLAND 1234 CASTLETON W. BRIGHTON, N. Y.	NORMAN M. CUMMINS 829 MAIN CINCINNATI, OHIO	GRACELAND HBYLAND 140 GRACELAND COLUMBUS, OHIO	THE TOY HSE 2063 FRONT CUYAHOGA FLS, OHIO	F. H. LONGFELLOW 414 GREENE MARIETTA, OHIO	MAIN TOY & HBY 137-39 MAIN TOLEDO 5, OHIO	BREWSTERS PEORIA at 10th ST TULSA, OKLA.
WYNKEN BLYNKEN NO. 3900 DEWEY ROCHESTER, N. Y.	GARDENSVILLE HDWE 3377 CLINTON W. SENECA, N. Y.	DONS CRANKSHAFT MOHAWK & ELM CINCINNATI, OHIO	MACS TRAIN REP U S 27 22 COLUM. 4, OHIO	BAKER MDLCRAFT 32188 SMITHVILLE DAYTON 20, OHIO	RABY HDWE 223 W. MAIN LOUISVILLE, OHIO	TRILEY SPT SHOP 5858 SECOR TOLEDO, OHIO	NORTHFIELD TOY GIFT 569 36th ST. TULSA, OKLA.
ROCK A BVE SHOP 621 TITUS AVE. ROCHESTER, N. Y.	ROSS TOY TOWN 65 E. MAIN WESTFIELD, N. Y.	DONS HBY SHOP 4915 GLENWAY CINCINNATI, OHIO	NWORBS ELEC. TRN 3243 WHITEHEAD COLUM. 4, OHIO	DAYTON MDY RLWAY 1318 WAYNE DAYTON, OHIO	LUSCH TV & HBY 812 BENNETT MARION, OHIO	BABYLAND JUVENILE 137 MAIN ST TOLEDO 5, OHIO	NORTHFIELD TOY & GIFT NORTHFIELD SHP CTR TULSA, OKLA.
HOBBYRAMA 280 SUNRISE HWY. ROCKVILLE CTR, N. Y.	SALLY'S CYCLE & TOY 213 HIGBIE LANE W. SLIP, N. Y.	HOBBY CTR 3738 GLENMORE CINCINNATI, OHIO	PEOPLES HDWE 15 E. MAIN CHILLICOTHE, OHIO	HOBBY CENTER 1400 N. MAIN DAYTON, OHIO	KRANTZ HBY SHOP 1036 STATE AVE. MASSILLON, OHIO	TROJAN NOVELTIES 424 RACE DR TROY, OHIO	DILLEY CY CTR 533 SOUTH ST. WARREN, OHIO
PLAY SHOP 234 W. DOMINICK ROME, N. Y.	WCHESTER HOBBY 102 E. POST WHITE PLAINS, N. Y.	HOBBY HAVEN 3470 SALEM DAYTON 6, OHIO	WESTERN AUTO 121 S. MAIN LENOIR, N. C.	KETTERING BIKE 3120 WILMINGTON DAYTON 29, OHIO	BALDRIDGE HOME 117 N. MAIN MARYSVILLE, OHIO	DON MERRIMAN 118 COLLEGE ST. WADSWORTH, OHIO	SPORTLAND 104 HIGH WARREN, OHIO
F. W. MEYERS & CO. MYERS BLDG ROUSE PT., N. Y.	WHITE PLAINS, N. Y.	JOES MUSIC & HBY 215 BEECHMONT CINCINNATI, OHIO	CRACK STRAUD CO. 501 W. 4th ST. WINSTON SALEM, N. C.	KNOLLWOOD HBY 7004 DAYTN KENIA DAYTON 32, OHIO	CHAMP ATH. SUP. 883 N. COURT MEDINA, OHIO	THE TRAHN HSE 688 MAHONING WARREN, OHIO	HOBBY HAVEN 901 BOND ST. BEND, ORE.
COONEY'S VARIETY 14 BROAD SALAMANCA, N. Y.	KRUGERS 179 MARTINE WHITE PLAINS, N. Y.	LEES HBY SHOP 2128 LOSANTVILLE CINCINNATI, OHIO	GEORGES HBY SHOP 834 W. 4th ST. WINSTON SALEM, N. C.	MILLER SPT GDS 256 E. STROOP DAYTON 29, OHIO	FUN SHOP, INC. 230 GRT LAKES MENTOR, OHIO		
WESTERN AUTO 44 MAIN SARANAC LAKE, N. Y.	JUMBLE HOBBIES 135 MAIN ST. PORT WASHINGTON, N. Y.	GEORGES HBY SHOP 834 W. 4th ST. WINSTON SALEM, N. C.					
BOBS HBY CTR 1724 UNION SCHENECTADY, N. Y.	GRELLS TOY HBY 5225 MAIN WILLIAMSVILLE, N. Y.						

SEE BOTTOM OF PAGE 31 FOR LATEST SERVICE STATION ADDITIONS IN YOUR STATE.

TOY & BOY TOWN  
307 CENTRAL  
COOS BAY, ORE.

TAYLORS SPT SHOP  
BOX 723  
COQUILLE, ORE.

LES & BOB SPT  
127 S. 4th  
CORVALLIS, ORE.

CLAUDE R. VUNK  
118 S. 2nd  
CORVALLIS, ORE.

EUGENES TOY & HBY  
98 E. 10th  
EUGENE, ORE.

THE HBY CORNER  
198 17th AVE.  
EUGENE, ORE.

B. A. MILLER HBY  
142 SE H ST  
GRANTS PASS, ORE.

WESTERN AUTO  
HALFWAY, ORE.

HILLSBORO HBY SHOP  
331 E. MAIN ST.  
HILLSBORO, ORE.

ERNIES  
928 KLAMATH  
KLAMATH FLS, ORE.

THE HBY WORLD  
124 S. 9th  
KLAMATH FLS, ORE.

THE HBY SHOP  
111 ADAMS  
LA GRANDE, ORE.

TOMMY'S BIKE HBY  
624 3rd ST.  
MCMINNVILLE, ORE.

SIMS CYCLE HBY  
23 N. FIR  
MEDFORD, ORE.

THE TOY HOUSE  
317 E. MAIN  
MEDFORD, ORE.

TOY WORLD  
MEDFORD SHPG  
MEDFORD, ORE.

BOSCHE COINS HBY  
3275 SE OAK GRV  
MILWAUKEE 22, ORE.

MILWAUKIE HBY CTR  
1208 MAIN  
MILWAUKIE 22, ORE.

TEDS TOYS  
OSWEGO, ORE.

LARRY'S HBY  
33 S. W. DORIN  
PENDLETON, ORE.

AERO SPORTS  
9720 S. E. DIV.  
PORTLAND, ORE.

N. F. ALBERTA  
2805 NE ALBERTA  
PORTLAND, ORE.

BECKWITH CYCLE  
4427 SE WOODSTK  
PORTLAND, ORE.

DARLENS TOYLAND  
10111 NE CLACKAMS  
PORTLAND, ORE.

EDS CAM SHOP  
7828 S. W. CAP HWY  
PORTLAND, ORE.

HOBBYLAND  
4508 N. INTERSTATE  
PORTLAND, ORE.

J. K. GILL CO.  
408 S. W. 5th  
PORTLAND 4, ORE.

HAWTHORNE CYCLE  
3701 SE HAWTHORNE  
PORTLAND, ORE.

HOOKS CYCLERY  
7850 SE STARK  
PORTLAND, ORE.

TOYLAND  
1305 LLOYD CTR  
PORTLAND, ORE.

VICS HBY SUP.  
1730 N. E 40th  
PORTLAND, ORE.

WEIRS CYCL & HBY  
500 S. LOMBARD  
PORTLAND 3, ORE.

W. SLOPE VAR.  
8775 SW CANYON  
PORTLAND 25, ORE.

WMS TOYS & HBY  
8952 SW BARBUR  
PORTLAND, ORE.

HENNINGS TOY HBY  
143 HIGH ST.  
SALEM, ORE.

SALEM TOY & HBY  
426 STATE  
SALEM, ORE.

TOYLAND  
1161 UNION  
SALEM, ORE.

TAMMIES TOY TWN  
TIGARD, ORE.

PENNSYLVANIA

BLOCHS PT & HBY  
918 HAMILTON  
ALLENSTOWN, PA.

MILLER HBY SHOP  
1715 NEW YORK  
ALLENSTOWN, PA.

POLLARDS  
328 NO. 7th ST.  
ALLENSTOWN, PA.

FERIS REITZ, INC.  
4707 RT. 8  
ALLISON PK, PA.

LAWRENCE HBY SHP  
404 E. WALTON  
ALTOONA, PA.

PHOTO & HBY CTR  
1423 11th AVE.  
ALTOONA, PA.

ARDMORE BIKE SHOP  
61 W. LANCASTER  
ARDMORE, PA.

SCHILLINGS  
1200 CENTER  
ASHLAND, PA.

ROLANDS  
407 3rd ST.  
BEAVER, PA.

PAUL'S HOBBOY SHOP  
190 ZEBBY AVE.  
KINGSTON, PA.

CONS SPT GDS  
733 W. FRONT  
BERWICK, PA.

CARLS  
925 W. BROAD  
BETHLEHEM, PA.

MACS HBY HALL  
315 W. 4th  
BETHLEHEM, PA.

KARVER & FRY  
128 E. PHILA.  
BOYERTOWN, PA.

SADOWSKY BROS.  
30 BRADDOCK  
BRADDOCK, PA.

TOOL & TOY  
1001 E. MAIN  
BRADFORD, PA.

AQUARIUM HBY S  
5 POND ST.  
BRISTOL, PA.

HBY & PET CTR  
2564 W. CHESTER PK  
BROOMALL, PA.

REEDS HBY SHOP  
215 S. MAIN  
BUTLER, PA.

SHEAFFER BROS.  
HANOVER & NO. ST.  
CARLISLE, PA.

TONY'S HBY SHOP  
101 S. 2nd ST.  
CARLISLE, PA.

BALCHIS  
542 MILL ST.  
CATAWISSA, PA.

UPTOWN SALES  
33 N. MAIN  
CHMBRSBURG, PA.

SIMMOND HBY CTR  
705 EDMONT  
CHESTER, PA.

STOTTERS DEPT STR.  
3rd & MARKET  
CHESTER, PA.

CLAIRSTON SPT SHP  
509 MILLER  
CLAIRSTON, PA.

DAISHERS HBY CTR  
17 N. THIRD  
CLEARFIELD, PA.

MILT GLASS CYCLE  
205 E. BALTO.  
CLIFTON HTS, PA.

MARTYS TOYLAND  
BALTO & BISHOP  
CLIFTON HTS, PA.

HARRYS HBY HSE  
708 E. LINCOLN HWY  
COATESVILLE, PA.

DELA VLY HBY  
302 W. 6th  
CONSHOHOCKEN, PA.

MICHAELS  
414 MILL  
CORAOPOLIS, PA.

B. B. MODEL CRAFT  
19 E. MAIN ST.  
DALLASTOWN, PA.

DOYLESTOWN HBY  
63 W. STRAND  
DOYLESTOWN, PA.

WARRENS HBY SHOP  
3713 GARERTT  
DREXEL HILL, PA.

WAY OFFICE SUP  
22 N. BRADY  
DUBOIS, PA.

RICHARDS HBYS  
RIDGE PIKE  
EGGLEVILLE, PA.

SADOWSKY BROS.  
GRT VLY MART  
E. McKEESPORT, PA.

BILLS HBY SHOP  
1717 BUTLER  
EASTON, PA.

HOBHY HANGOUT  
509 NORTHAMPTON  
EASTON, PA.

ROCKYS HBYS  
333 E. BAINBRIDGE  
ELIZABETHTOWN, PA.

WILLARD DONEY  
412-14 CHESTNUT  
EMMAUS, PA.

EPHRATA SPTS CTR  
9 & 10 E. MAIN  
EPHRATA, PA.

DONS MODEL  
2312 PEACH  
ERIE, PA.

ERIE DRY GDS CO.  
718 STATE  
ERIE 1, PA.

SPORTSMAN, INC.  
912 PLAZA BLVD  
ERIE, PA.

FEASTERVILLE HBY  
244 BUSTLETON  
FEASTERVILLE, PA.

FLOURTOWN SPORT  
1664 BETH. PK.  
FLOURTOWN, PA.

DON MOHRS HBYLAND  
FOGELSVILLE, PA.

GILBERT HBY SHOP  
230 STEINWEHR  
GETTYSBURG, PA.

KEWICK CYCLE CO.  
408 N. EASTON  
GLENDEN, PA.

COLLIER TRAIN SERV.  
1283 W. PITTSBURG  
GREENSBURG, PA.

THE POWDER HORN  
46 N. MAIN ST.  
GREENSBURG, PA.

DELL'S TOY SHOP  
3502 MAIN ST.  
MUNHALL, PA.

F & S SHOP  
4th & STATE  
HAMBURG, PA.

STRIKCLERS HBY  
512 BROADWAY  
HANOVER, PA.

BEAVERS HBY STR  
BOX 934  
HARRISBURG, PA.

PFUFF SALES SERV.  
2831 PENBRANK  
HARRISBURG, PA.

RUSS HBY SHOP  
138 S. 17th  
HARRISBURG, PA.

VINCES HBY CRAFTS  
206 LOCUST  
HARRISBURG, PA.

HALLS HBY CTR  
18 BROOKLINE  
HAVERTOWN, PA.

HOBBY HAVEN  
128 N. WYOMING  
HAZELTON, PA.

TIP TOP HBY  
64 N. WYOMING  
HAZELTON, PA.

C. H. MILLER HDWE  
704 WASH. ST.  
HUNTINGTON, PA.

DERMITTS HBY  
804 PHILA. ST.  
INDIANA, PA.

JENKINTWN HBY  
GRND & LEEDOM  
JENKINTOWN, PA.

BUCKS  
101 MARKET  
JOHNSTOWN, PA.

DICKS HBY CTR  
NARROWS SHP CTR  
KINGSTON, PA.

FELSINGERS HBY SHOP  
2712 COLUMBIA  
LANCASTER, PA.

RULES HBY SHOP  
635 N. QUEEN  
LANCASTER, PA.

WIELANDS HBY  
315 N. QUEEN  
LANCASTER, PA.

WITMERS  
COLLEGE & LEMON  
LANCASTER, PA.

WINKY DINKY TOY STR.  
C. T. HOBBIES  
16 W. KING ST.  
LANCASTER, PA.

LANSDALE HBY SHOP  
MAIN & BROAD  
LANSDALE, PA.

LANSDALE LAWN GRDN  
W. MAIN  
LANSDALE, PA.

PENN LAWN SHOP  
W. MAIN  
LANSDALE, PA.

PENN VALLEY HBY  
317 W. MAIN  
LANSDALE, PA.

BARNEY MDL TRN  
718 E. RIDGE  
LANSFORD, PA.

THE HOBHY SHOP  
1315 LEGONIER  
LATROBE, PA.

PETERMAN'S HBY & PAI  
1015 LEGONIER ST.  
LATROBE, PA.

HILL CYCLE SHOP  
1300 FLORENCE  
LEBANON, PA.

FIVE POINTS HBY  
6924 EMILIE  
LEVITTOWN, PA.

LEVITTOWN HBY CTR  
9 & 10 E. MAIN  
LEVITTOWN, PA.

GRABES HOBBIES  
140 VALLEY ST.  
LEVITTOWN, PA.

OSBORNES HBY SHOP  
44 BELLEFONTE  
LOCK HAVEN, PA.

ODDYS HBY CTR  
338 SHAW  
MCKEESPORT, PA.

DE NOON PAINT  
886 MARKET  
MEADVILLE, PA.

BISHOPS TOYS & HBY  
33 E. STATE  
MEDIA, PA.

ALLENS WESTN AUTO  
18 SO. FRONT  
MILTON, PA.

MESSNER & HESS  
207 SUNBURY  
MINERSVILLE, PA.

SULLY HBY TOYLAND  
310 DONNER  
MONESSEN, PA.

LORESKIS  
MIRACLE MI SHP CTR  
MONROEVILLE, PA.

MONTROSE WSN AUTO  
MONTROSE, PA.

KLINGERS STORE  
10 W. SHIRLEY  
MT. UNION, PA.

SMITH HBY CYCLE  
204 W. MAIN  
MORRISTOWN, PA.

DELL'S TOY SHOP  
3502 MAIN ST.  
MUNHALL, PA.

JR. DEPT STORE  
EAST MAIN  
NANTICOKE, PA.

ZIGS HBY STORE  
75 E. MAIN  
NANTICOKE, PA.

MAJESTIC WALLPAPER  
204 W. MAIN  
NEWCASTLE, PA.

DOUDS HBY & MDLCRT  
232 E. WASH. ST.  
NEW CASTLE, PA.

T & C HBY HSE  
404 TENTH  
NEW KENSINGTON, PA.

NEWTON RADIO & EA  
29 SO. STATE  
NEWTON, PA.

BILL GLASS BIKE  
200 W. MAIN  
NORRISTOWN, PA.

NORRISTOWN HBY  
417 W. MARSHALL  
NORRISTOWN, PA.

SMITH HBY  
2041 W. MAIN  
NORRISTOWN, PA.

TOY BARN  
FREEMPT RD.  
NO. EAST, PA.

FRYE HOME FURN  
130 QUEEN  
NRHUMBERLAND, PA.

KERN MDL RR STR  
9 PETROLEUM  
OIL CITY, PA.

TOY CARNIVAL  
117 LACKAWANNA  
OLYHANT, PA.

ALBERTS TOY MART  
6121 RIDGE  
PHILA. 28, PA.

ALLIED HOBBIES  
21 S. 16th ST.  
PHILA., PA.

ALLIED HOBBIES  
6607 RISING SUN  
PHILA. 11, PA.

C. T. HOBBIES  
1714 BRIDGE  
PHILA. 24, PA.

CARLS HBY SHOP  
218 E. CLEARFLD  
PHILA., PA.

COLORIZE HBYS  
5638 N. 5th  
PHILA., PA.

D & S HDWE ELECT  
5936-38 TORRESDALE  
PHILA. 24, PA.

E & H MODEL HBYS  
7333 FRANKFORD  
PHILA. 36, PA.

E & H MODEL HBYS  
2379 CHELTENHAM  
PHILA. 50, PA.

E & H MODEL HBYS  
160 W. CHELTEN  
PHILA. 4, PA.

PHIL EVANS HBY  
4454 FRANKFORD  
PHILA., PA.

HILL CYCLE SHOP  
8153 GERMANTOWN  
PHILA., PA.

DAVE KEY  
4929 N. 5th  
PHILA., PA.

KENDITERS HBY HSE  
7025 ELMWOOD  
PHILA. 42, PA.

MACKS PHOTO & HBY  
839 E. ALLEGHENY  
PHILA. 34, PA.

OGONTZ HOME AUTO  
7305 OGONTZ  
PHILA. 38, PA.

QUAKER CITY HBY  
620 MARKET  
PHILA., PA.

NICHOLAS SMITH  
20 S. 11th ST.  
PHILA. 7, PA.

SOBELS  
6612 CASTOR  
PHILA. 49, PA.

STANLEY HBY  
7120 FRANKFORD  
PHILA., PA.

TOM THUMB HBY  
122 S. 16th  
PHILA., PA.

K & H WETZEL CYC  
4934 N. 5th  
PHILA., PA.

WOLKENS  
48 S. 60th ST.  
PHILA. 39, PA.

NORTHEAST HBY SHOP  
2503 E. ALLEGHENY  
PHILA., PA.

ROXY KIDDIE TOY  
225 AV. J  
PHILA. 28, PA.

FRANKS SPT SHOP  
122 PINE  
PHILBURGH, PA.

A T SELLERS  
WESTERN AUTO  
PHILBURGH, PA.

DONALD L. ERT  
243 BRIDGE  
PHOENIXVILLE, PA.

BILL & WALTS HBY  
20 S. 5th  
PITTSBURGH, PA.

BURLAND HBY SHOP  
4801 MCKNIGHT RD.  
PITTSBURGH, PA.

A B CHARLES & SON  
3213 W. LIBERTY  
PITTSBURGH 6, PA.

COM RADIO ELEC.  
7429 PENN.  
PITTSBURGH, PA.

EAST HILLS HBY  
EAST HILLS SHP CTR  
PITTSBURGH 35, PA.

ESTHERS HBY & TOY  
219 NORTH AVE.  
PITTSBURGH 9, PA.

F & L APPL ELEC  
69 AMANDA  
PITTSBURGH 10, PA.

GLENN'S SPT HBY  
4129 BROOKVILLE  
PITTSBURGH 27, PA.

HARRY'S HBY SHOP  
2929 SHADELAND  
PITTSBURGH 12, PA.

JOHN A. SACCO JR.  
30 INGRAM  
PITTSBURGH 5, PA.

LUCAS HBY CTR  
802 BROOKLINE  
PITTSBURGH 26, PA.

WHITEHEAD HDWE  
N. HIAS VIL. CTR  
PITTSBURGH 37, PA.

WESTERN AUTO SUP.  
3142 W. LIBERTY AVE.  
PITTSBURGH, PA.

HOBHY SHOP  
575 CHESTER PK  
PROSPECT PK, PA.

C & S MARKET  
BOX 330 RD 2  
PUNXSUTAWNEY, PA.

OTT'S TOYS  
536 NO. 10th ST.  
READING, PA.

HOBHY HAVEN  
READING FAIR GRND  
READING, PA.

JOHN ZOCCO  
200 S. 4th  
READING, PA.

WEIKELS TOY & SPT  
2633 MAIN  
ROYERSFORD, PA.

BOBS SPTG GDS  
717 SPRING  
SAXTON, PA.

JOES SPT GDS  
106 W. LOCKHART  
SAYRE, PA.

MESSNER & HESS  
14 E. MAIN  
SCHULKY HAVEN, PA.

BILLS SPTG GDS.  
1907 N. MAIN  
SCRANTON, PA.

SCRANTON HBY  
331 ADAMS  
SCRANTON, PA.

TREDS BK & HBY  
113 N. MAIN  
SCRANTON, PA.

MALETT'S VARIETY STR  
316 E. INDEPENDENCE  
SHAMOKIN, PA.

MHLLBAUGHS  
80 SHENANGO  
SHARON, PA.

PLAZA CAM HBY  
HICKORY PLAZA  
SHARON, PA.

C. NYES GUN TCKL  
ORANGE & HOLLAR  
SHIPPENSBURG, PA.

BROADBENTS  
44 2nd ST PK  
SOUTHAMPTON, PA.

THE HBY HSE  
502 MAIN  
STROUDSBURG, PA.

WM. A. THORNE  
441 EVERS  
ST. MARYS, PA.

SCHRADERS CORNER  
4th & REAGAN  
SUNBURY, PA.

H & K HOBBY SHP  
178 SIMPSON  
SWOYARVILLE, PA.

TEMPLE PAINTS & HBY  
4877 KUTZ  
TEMPLE, PA.

JAN & JEFF  
253 S. MT. VERNON  
UNIONTOWN, PA.

UNIONTOWN HBY  
36 W. SOUTH ST.  
UNIONTOWN, PA.

TODDS MDL SHOP  
7036 TERMINAL  
UPPER DARBY, PA.

OLYMPIA HBY SHOP  
35 OLYMPIA SHPG  
VERSAILLES, PA.

N K WNDLBOE CO.  
217 LIBERTY  
WARREN, PA.

JD'S JEWELRY & HBY SHP  
104 W. CHESTNUT ST.  
WASHINGTON, PA.

PHOENIX HDWE & HBY  
21 E. CHESTNUT  
WASHINGTON, PA.

BILLS HBY SHOP  
2917 BUFFALO  
WESTLEYVILLE, PA.

S & H HDW & SUP. CO.  
6624 CASTOR AVE.  
PHILA. 49, PA.

HUMMELS BIKE & TOY  
110 N. DWIGHT  
WEST LAFAYETTE, PA.

FOUR SEASONS  
MIFFLIN MNR SHP CTR  
W. MIFFLIN, PA.

THE HOBHY SHOP  
8 W. NORTHAMPTON  
WILKES BARRE, PA.

COMMUNITY RADIO  
45 PENN  
WILKINSBUR, PA.

STEPS HBY SHO  
246 PINE  
WILLIAMSPORT, PA.

BOB TOMKINS MDL  
8 W. 4th ST.  
WILLIAMSPORT, PA.

WILLOW GRV PHOTO  
EASTON ROAD  
WILLOW GRV, PA.

M. VALENTIS HBYS  
1220 GRAHAM  
WINDBER, PA.

CHECKERED FLAG  
401 W. MARKET  
YORK, PA.

G & L HBY SHOP  
19 N. SEWARD  
YORK, PA.

MODEL CRAFT SHOP  
115 GEORGE  
YORK, PA.

ROGERS TOY STR  
YORK CO. SHP CTR  
YORK, PA.

SKELLY SPT GDS  
2227 W. MARKET  
YORK, PA.

RHODE ISLAND

APPONAUG COLOR SHP  
1364 GREENWICH  
APPONAUG, R. I.

CENTRAL HOBBIES  
178 VALLEY  
CENTRAL FLS, R. I.

HOBBYVILLE  
564 PLAINFIELD  
PROVIDENCE, R. I.

AUSTIN ELECTRIC  
3430 WEST END  
NASHVILLE, TENN.

JP BROWN DRUG  
3907 NOLENSVILLE  
NASHVILLE, TENN.

HOBBYLAND  
8 WINDENEMERE  
CHARLESTON, S. C.

CLOVER REP. SERV.  
209 KNOX  
CLOVER, S. C.

HILLMANS  
1216 TAYLOR  
COLUMBIA, S. C.

B DELANYS SPTG  
209 N. MAIN  
GREENVILLE, S. C.

W. A. ROBINSON  
108 W. VIEW DR.  
EASLEY, S. C.

MARIONS HBY & SPT  
2109 AUGUSTA  
GREENVILLE, S. C.

BUNDYS TOYLAND  
715 S. MAIN  
LANCASTER, S. C.

SUMMERS HBY SHOP  
BOX 153  
NEWBERY, S. C.

HARRIS SPT GDS.  
114 ST  
SENECA, S. C.

HOBHY SHOP  
228 E. MAIN  
SPARTANBURG, S. C.

SOUTH DAKOTA

STEARNS & SHEDD  
DEADWOOD, S. D.

SPARGUR HWE  
PIERRE, S. D.

TOY HBY TR  
522 ST. JOE  
RAPID CITY, S. D.

WHOS HBY HOUSE  
520 8th ST. BOX 1146  
RAPID CITY, S. D.

UNIVERSAL HBY HSE  
125 W. 10th ST.  
SIOUX FLS, S. D.

HALEYS S & O HDWE  
936 1st ST.  
STURGIS, S. D.

TENNESSEE

A & M TOY & HBY  
3516 RINGOLD  
CHATTANOOGA, TENN.

CURTIS HBYS  
2603 W. 22nd  
AMARILLO, TEX.

AMARILLO HBY HSE  
118 E. 7th  
AMARILLO, TEX.

PHILS HBY  
RIVER OAKS  
ABILENE, TEX.

HOBHY TOWN  
5293 RYAN  
AUSTIN, TEX.

TOY TOWN  
5316 CAMERON  
AUSTIN, TEX.

TOY PALACE, INC.  
1309 LAVALA  
AUSTIN, TEX.

HAPPY LOBBY  
306 ORLEANS  
BEAUMONT, TEX.

HOBHY TOWN  
5224 CEDAR ST.  
BELLAIRE 101, TEX.

HOBHY TOWN  
5224 CEDAR ST.  
BELLAIRE 101, TEX.

SPORTSMAN TOYLAND  
1608 GREGG  
BIG SPRING, TEX.

MACS HOBBIES  
743 E. ELIZABETH  
BROWNSVILLE, TEX.

PAULSON REPAIR  
3815 RAY  
BRYAN, TEX.

BROWNS  
1406 3rd ST.  
CORPUS CHRISTI, TEX.

C & C TOY & HBY  
515 CLIFFORD  
CORPUS CHRISTI, TEX.

TOY HOUSE  
51 PARKDALE  
CORPUS CHRISTI, TEX.

JOE WEIL HDWE  
3844 LEXINGTON  
CORPUS CHRISTI, TEX.

JOHN DAVERN  
519 W. JEFFERSON  
DALLAS, TEX.

FIELDS HBYCRAFT  
235 NORTHWEST CTR  
DALLAS 18, TEX.

BERNARD J. HAIRE  
209 W. JEFFERSON  
DALLAS, TEX.

HALLS HBY HSE  
4822 BRYAN  
DALLAS, TEX.

B HALLS HBY HSE  
2267 GUS THOMASON  
DALLAS 28, TEX.

HOBHY COUNTER  
1905 GREENVILLE  
DALLAS, TEX.

HOBBYLAND  
1527 CENTREVILLE  
DALLAS, TEX.

INWOOD CYCLE  
5627 W. LOVERS  
DALLAS, TEX.

BURRUS HDWE  
3813 WILLA  
NASHVILLE, TENN.

CARUTHERS 5 & 10  
4108 GALLATIN  
NASHVILLE, TENN.

BEN FRANKLIN 2031  
2603 FRANKLIN  
NASHVILLE, TENN.

GANTS HOBBIES  
5915 CHARLOTTE  
NASHVILLE, TENN.

INGLEWOOD HBY  
3521 GALLATIN  
NASHVILLE, TENN.

B DELANYS SPTG  
209 N. MAIN  
GREENVILLE, S. C.

W. A. ROBINSON  
108 W. VIEW DR.  
EASLEY, S. C.

MARIONS HBY & SPT  
2109 AUGUSTA  
GREENVILLE, S. C.

BUNDYS TOYLAND  
715 S. MAIN  
LANCASTER, S. C.

SUMMERS HBY SHOP  
BOX 153  
NEWBERY, S. C.

HARRIS SPT GDS.  
114 ST  
SENECA, S. C.

HOBHY SHOP  
228 E. MAIN  
SPARTANBURG, S. C.

SOUTH DAKOTA

STEARNS & SHEDD  
DEADWOOD, S. D.

SPARGUR HWE  
PIERRE, S. D.

TOY HBY TR  
522 ST. JOE  
RAPID CITY, S. D.

WHOS HBY HOUSE  
520 8th ST. BOX 1146  
RAPID CITY, S. D.

UNIVERSAL HBY HSE  
125 W. 10th ST.  
SIOUX FLS, S. D.

HALEYS S & O HDWE  
936 1st ST.  
STURGIS, S. D.

TENNESSEE

A & M TOY & HBY  
3516 RINGOLD  
CHATTANOOGA, TENN.

CURTIS HBYS  
2603 W. 22nd  
AMARILLO, TEX.

AMARILLO HBY HSE  
118 E. 7th  
AMARILLO, TEX.

PHILS HBY  
RIVER OAKS  
ABILENE, TEX.

HOBHY TOWN  
5293 RYAN  
AUSTIN, TEX.

TOY TOWN  
5316 CAMERON  
AUSTIN, TEX.

TOY PALACE, INC.  
1309 LAVALA  
AUSTIN, TEX.

HAPPY LOBBY  
306 ORLEANS  
BEAUMONT, TEX.

HOBHY TOWN  
5224 CEDAR ST.  
BELLAIRE 101, TEX.

HOBHY TOWN  
5224 CEDAR ST.  
BELLAIRE 101, TEX.

SPORTSMAN TOYLAND  
1608 GREGG  
BIG SPRING, TEX.

MACS HOBBIES  
743 E. ELIZABETH  
BROWNSVILLE, TEX.

PAULSON REPAIR  
3815 RAY  
BRYAN, TEX.

BROWNS  
1406 3rd ST.  
CORPUS CHRISTI, TEX.

C & C TOY & HBY  
515 CLIFFORD  
CORPUS CHRISTI, TEX.

TOY HOUSE  
51 PARKDALE  
CORPUS CHRISTI, TEX.

JOE WEIL HDWE  
3844 LEXINGTON  
CORPUS CHRISTI, TEX.

JOHN DAVERN  
519 W. JEFFERSON  
DALLAS, TEX.

FIELDS HBYCRAFT  
235 NORTHWEST CTR  
DALLAS 18, TEX.

BERNARD J. HAIRE  
209 W. JEFFERSON  
DALLAS, TEX.

HALLS HBY HSE  
4822 BRYAN  
DALLAS, TEX.

B HALLS HBY HSE  
2267 GUS THOMASON  
DALLAS 28, TEX.

HOBHY COUNTER  
1905 GREENVILLE  
DALLAS, TEX.

HOBBYLAND  
1527 CENTREVILLE  
DALLAS, TEX.

INWOOD CYCLE  
5627 W. LOVERS  
DALLAS, TEX.

SEE BOTTOM OF PAGE 31 FOR LATEST SERVICE STATION ADDITIONS IN YOUR STATE.

PARK FOREST CYCLE  
302 PK FOREST  
DALLAS 29, TEX.

ROYAL HBY CTR  
164 WEBB ROY SHP  
DALLAS, TEX.

SHERMANS LAKEWOOD  
6324 LA VISTA  
DALLAS 14, TEX.

WALNUT HILL HBY  
160 WALNUT HILL  
DALLAS 20, TEX.

WONDERLAND TOY  
227 PLEASANT  
DALLAS, TEX.

HURLEY'S ELECTRONIC  
535 SO. LOCUST  
DENTON, TEXAS

HOBBY HAVEN  
111 W. EULESS  
EULESS, TEX.

AERO HOBBIES  
8548 DYER  
EL PASO 4, TEX.

HALS HBY SHOP  
1320 DYER  
EL PASO, TEX.

KAYS HBY SHOP  
6536 MEADOWBRK  
FT. WORTH, TEX.

TOLSON'S MDCRAFT  
3404 CP BOWIE  
FT. WORTH, TEX.

TRI FOTO STUDIOS  
3311 E. LANCASTER  
FT. WORTH, TEX.

WESTCLIFF TOY SHOP  
14 WESTCLIFF  
FT. WORTH, TEX.

THE HO TRAIN ROOM  
3311 E. LANCASTER  
FT. WORTH 3, TEX.

RIVER OAKS HBY  
5431 RIVER OAKS  
FT. WORTH, TEX.

GARLAND HOBBY  
717 S. FIFTH  
GARLAND, TEX.

TOYTOWN HARLINGEN  
316 E. JACKSON  
HARLINGEN, TEX.

ABC MODEL SUP.  
305 GULFSTATE MALL  
HOUSTON, TEX.

ACE HOBBIES  
5409 NORDLING  
HOUSTON 9, TEX.

G & G MODEL SHOP  
2522 TIMES BLVD  
HOUSTON, TEX.

MCT HBY CTR DIV.  
1311 TEXAS AVE.  
BRYAN, TEXAS

HOBBY HAVEN  
1019 PERRY  
IRVING, TEX.

KERRVILLE ART HBY  
727 WATER ST.  
KERRVILLE, TEX.

ROY'S CAM NOOK  
217 E. KLEBERG  
KINGSVILLE, TEX.

LA PORTE HDWE  
BOX 938, 228 W. MAIN  
LA PORTE, TEX.

MAC'S TOYS  
1113 TURBIDE  
LAREDO, TEX.

WESTERN AUTO  
720 CONVENT  
LAREDO, TEX.

HOGUES GIFT SHOP  
715 AVE. G  
LEVELLAND, TEX.

HART THAYTON HDWE  
523 PHELPS  
LITTLEFIELD, TEX.

KLEEB'S TOY RANCH  
1211 ALPINE  
LONGVIEW, TEX.

HOBBY HUB  
3205 B 34th ST.  
LUBBOCK, TEX.

JONES HBY CRAFT  
2642 34th ST.  
LUBBOCK, TEX.

MILANS TOYLAND  
1402 BROADWAY  
LUBBOCK, TEX.

MINTERS  
2135 19th ST.  
LUBBOCK, TEX.

MONTEREY GIFT  
MONTEREY SHPG CTR  
LUBBOCK, TEX.

ANDREWS HBY SHOP  
3519 CALVEY  
MARSHALL, TEX.

BOSWELL HBY CTR  
3310 W. ILL.  
MIDLAND, TEX.

PEYTONS  
MOGFOR & MICH.  
MIDLAND, TEX.

WILCOX HDWE  
506 W. WALL  
MIDLAND, TEX.

VALLEY SPT CTR  
115 S. MAIN  
MCALEEN, TEX.

HOLCOMBS  
1214 W. 10th  
ODESSA, TEX.

LOU & PAULS HBY  
3619 E. C. RD.  
ODESSA, TEX.

PEYTONS HBY CTR  
3519 CALVEY RD  
ODESSA, TEX.

JR HBY SHOP  
709 OAKLAND  
PLAINVIEW, TEX.

PT. ARTHUR HBY  
725 STILLWELL  
PT. ARTHUR, TEX.

HAMERS HBY'S  
1420 N. McCULLOUGH  
RICHARDSON, TEX.

BALEMAN SPT GDS.  
15 W. TWIGH  
SAN ANGELO, TEX.

WILSONS HBY  
2205 W. BEAUREGARD  
SAN ANGELO, TEX.

CES & RONNIES HBY  
1420 N. McCULLOUGH  
SAN ANTONIO, TEX.

DIBBLES TOY HBY  
1029 DONALDSON  
SAN ANTONIO, TEX.

DICKS HBY SHOP  
6614 SEIDEL  
SAN ANTONIO, TEX.

ARTHUR LANG  
4908 S. FLORES  
SAN ANTONIO, TEX.

THE HOBBY SHOP  
3829 S. 15th  
SWEETWATER, TEX.

SUTTONS HBY SHOP  
404 6th ST.  
TEXAS CITY, TEX.

TYLER TOY HSE  
GREEN ACRES SHP  
TYLER, TEX.

VILLAGE HBY SHOP  
2509 N. AZALEA  
VICTORIA, TEX.

BAUGH MODEL SHOP  
512 N. 29th  
WACO, TEX.

BEVERLY HILLS MDL  
1105 A S. VALY MLS DR  
WACO, TEX.

HOBBY CORNER  
8054 VA. BEACH  
NORFOLK, VA.

MEADOW HBY HOUSE  
POB 246, 4 N. WASH  
NORFOLK, VA.

OCEAN VIEW HBY  
404 E. OCEANVIEW  
NORFOLK, VA.

ZEPHR MINIATURES  
123 W. LTL CRK RD  
NORFOLK 5, VA.

ORANGE SPORTSMAN  
131 E. MAIN ST.  
ORANGE, VA.

WESTERN AUTO ASSOC.  
PEARLSBURG, VA.

BOBS HBY CTR  
3029 W. CARY  
RICHMOND, VA.

BOLLING FRANKS  
5075 FOREST HILL  
RICHMOND, VA.

HOBBYLAND  
THREE CHPT  
RICHMOND 29, VA.

KEELS HBY SHOP  
107 N. 2nd  
RICHMOND, VA.

VERMONT  
BENNINGTON HY  
416 MAIN ST.  
BENNINGTON, VT.

CASTLERS TOYS  
536 N. WINDOSKI  
BURLINGTON, VT.

HOUSE OF HBYS  
141 WEMPLE  
BURLINGTON, VT.

MIDD WAY SHOP  
61 MAIN  
MIDDLEBURY, VT.

LESTERS TOY & HBY  
CROSSROADS SHP  
ROANOKE, VA.

S. NORFOLK HBY SHOP  
1329 PINEDECKER  
NO. NORFOLK, VA.

R. R. ALLEN CO.  
129 W. WASH  
SUFFOLK, VA.

THE HOBBY SHOP  
255 W. WASH  
SUFFOLK, VA.

GARSTS  
514 W. MAIN  
WAYNESBORO, VA.

MARKS SPT SHOP  
150 RICHMOND  
WILLIAMSBURG, VA.

JACKS HBY CRAFT  
38 S. LOUDON  
WINCHESTER, VA.

WASHINGTON  
WALT FAILORS SPT  
BELCHER BLDG  
ABERDEEN, WASH.

METRO SERV.  
28 S. PERSHING  
ARLINGTON, VA.

WESTERN AUTO  
BARRACKS RD  
CHARLOTTESVILLE, VA.

PIEDMONT HDWE  
554 CRAGHEAD  
DANVILLE, VA.

HOBBYLAND  
931 KEAN LIGHTON RD.  
HAMPTON, VA.

FALLS CHURCH HBY  
171 S. WASH.  
FALLS CHURCH, VA.

VINCENTS OCTAGON  
132 E. LEE HWY  
FAIRFOX, VA.

FREDKSBURG AUTO SU  
618 KENMORE  
FREDKSBURG, VA.

HOBBYLAND SUSSEX  
3829 S. 15th  
HAMPTON, VA.

E. HAYDEN HBY SHOP  
42 W. BRIDGE  
HARRISONBURG, VA.

VA CENT MODEL RR  
10 LEE  
LEXINGTON, VA.

S. O. FISCHER  
PITTMAN PLAZA  
LYNCHBURG, VA.

MCLEAN SPT & HBY  
4806 CHAIN BRG RD  
MCLEAN, VA.

HANKS HBY SHOP  
5034 E. PRNC ANN  
NORFOLK 2, VA.

EVERETT MDL SHOP  
2605 COLBY  
EVERETT, WASH.

EVERGREEN PET HBY  
5000 EVERGREEN HWY  
EVERETT, WASH.

FT. LEWIS EXCH.  
FT. LEWIS, WASH.

OTHEIMS WESTERN  
VAN ALDER  
KENNEWICK, WASH.

BOBS LYNWD HBY SHP  
LYNNWOOD SHP CTR  
LYNNWOOD, WASH.

FRENCHS SHOW HSE  
118 N. WENATCHEE  
WENATCHEE, WASH.

BEAUDRY'S HBY  
VISTA SHP CTR  
MOSES LAKE, WASH.

DELS CYCLE  
928 S. DIVISION  
MOSES LAKE, WASH.

ROBERTS HANDICRAFT  
515 1st ST.  
MT. VERNON, WASH.

CHRYS TELLS  
415 CAPITOL  
OLYMPIA, WASH.

MAC'S HBY SHOP  
1076 E. SPRAGUE  
OPPORTUNITY, WASH.

SHOP ETTE DEPT  
13222 PACIFIC  
PARKLAND, WASH.

ROBINSON HOBBY  
306 N. ROBINSON ST.  
RICHMOND 20, VA.

THE TOY STORE  
5811 PATTERSON  
RICHMOND, VA.

GARLANDS  
1327 GRANDIN  
ROANOKE, VA.

LESTERS TOY & HBY  
CROSSROADS SHP  
ROANOKE, VA.

S. NORFOLK HBY SHOP  
1329 PINEDECKER  
NO. NORFOLK, VA.

R. R. ALLEN CO.  
129 W. WASH  
SUFFOLK, VA.

THE HOBBY SHOP  
255 W. WASH  
SUFFOLK, VA.

GARSTS  
514 W. MAIN  
WAYNESBORO, VA.

MARKS SPT SHOP  
150 RICHMOND  
WILLIAMSBURG, VA.

JACKS HBY CRAFT  
38 S. LOUDON  
WINCHESTER, VA.

WASHINGTON  
WALT FAILORS SPT  
BELCHER BLDG  
ABERDEEN, WASH.

METRO SERV.  
28 S. PERSHING  
ARLINGTON, VA.

WESTERN AUTO  
BARRACKS RD  
CHARLOTTESVILLE, VA.

PIEDMONT HDWE  
554 CRAGHEAD  
DANVILLE, VA.

HOBBYLAND  
931 KEAN LIGHTON RD.  
HAMPTON, VA.

FALLS CHURCH HBY  
171 S. WASH.  
FALLS CHURCH, VA.

VINCENTS OCTAGON  
132 E. LEE HWY  
FAIRFOX, VA.

FREDKSBURG AUTO SU  
618 KENMORE  
FREDKSBURG, VA.

HOBBYLAND SUSSEX  
3829 S. 15th  
HAMPTON, VA.

E. HAYDEN HBY SHOP  
42 W. BRIDGE  
HARRISONBURG, VA.

VA CENT MODEL RR  
10 LEE  
LEXINGTON, VA.

S. O. FISCHER  
PITTMAN PLAZA  
LYNCHBURG, VA.

MCLEAN SPT & HBY  
4806 CHAIN BRG RD  
MCLEAN, VA.

HANKS HBY SHOP  
5034 E. PRNC ANN  
NORFOLK 2, VA.

EVERETT MDL SHOP  
2605 COLBY  
EVERETT, WASH.

EVERGREEN PET HBY  
5000 EVERGREEN HWY  
EVERETT, WASH.

FT. LEWIS EXCH.  
FT. LEWIS, WASH.

OTHEIMS WESTERN  
VAN ALDER  
KENNEWICK, WASH.

BOBS LYNWD HBY SHP  
LYNNWOOD SHP CTR  
LYNNWOOD, WASH.

FRENCHS SHOW HSE  
118 N. WENATCHEE  
WENATCHEE, WASH.

BEAUDRY'S HBY  
VISTA SHP CTR  
MOSES LAKE, WASH.

DELS CYCLE  
928 S. DIVISION  
MOSES LAKE, WASH.

ROBERTS HANDICRAFT  
515 1st ST.  
MT. VERNON, WASH.

CHRYS TELLS  
415 CAPITOL  
OLYMPIA, WASH.

MAC'S HBY SHOP  
1076 E. SPRAGUE  
OPPORTUNITY, WASH.

SHOP ETTE DEPT  
13222 PACIFIC  
PARKLAND, WASH.

BAILEYS TOYS HBY  
206 N. ROBINSON ST.  
RICHMOND 20, VA.

WOODS SAFE LOCK  
930 W. LEWIS  
PASCO, WASH.

HOBBY LOBBY  
131 MAIN  
PULLMAN, WASH.

ARLEN'S PET & HBY  
720 E. MAIN  
PLYMOUTH, WASH.

KISSELS VARIETY  
BOX 1227  
QUINCY, WASH.

A 1 HBY SUPPLY  
421 OLIVE  
SEATTLE 1, WASH.

DONS SPTG GDS.  
NORTHGATE PLAZA  
SEATTLE, WASH.

DOWS HOBBIES  
2665 NW WELCH MALL  
SEATTLE, WASH.

EMPIRE HOBBIES  
6740 EMPIRE  
SEATTLE, WASH.

GREENWOOD HBY  
8414 GREENWOOD  
SEATTLE, WASH.

HOBBY CRAFT  
THE BON MARCHE  
SEATTLE, WASH.

NORTH END HBY  
923 COTA WY  
SEATTLE, WASH.

PARKERS HBY CTR  
445 SW 152  
SEATTLE, WASH.

ROCKWOOD CYCLE CO.  
12 McGROW ST.  
SEATTLE 9, WASH.

SKYWAY JEWELERS  
12621 RENTON  
SEATTLE 88, WASH.

SOUTHGATE HBY  
633 SW 50th  
SEATTLE 66, WASH.

WESTERN SCALE MOD  
1769 15th AVE.  
SEATTLE 44, WASH.

WOLPHS HBY SHOP  
5999 RAINIER  
SEATTLE 18, WASH.

CLINTONS BIK & FIX  
223 W. ALDER  
SHELTON, WASH.

COLUMBIA CYCLE  
1930 N. MONROE  
SPOKANE 17, WASH.

MARTYS TOYLAND  
2216 E. SPRAGE  
SPOKANE, WASH.

McCOY'S GIFT & HBY  
104 SHADE CTR  
SPOKANE, WASH.

MAURIES MDL SHOP  
500 W. WASHINGTON  
SPOKANE 10, WASH.

HOBBY BYKE  
735 BROADWAY  
TACOMA, WASH.

PERKINS CYCLE  
2610 N. PROCTOR  
TACOMA, WASH.

HARRY'S CYCLE & HBY  
2309 MAIN  
TACOMA, WASH.

DAN REEDER HBY  
18 W. ALDER  
WALLA WALLA, WASH.

REEDS FURN & TOY  
118 N. WENATCHEE  
WENATCHEE, WASH.

WELLS & WADE HDWE  
WENATCHEE, WASH.

WENATCHEE CYC & TOY  
228 S. WENATCHEE  
WENATCHEE, WASH.

CLOVER LEAF HBY  
10 N. 4th ST.  
YAKIMA, WASH.

YAKIMA CYCLE SHOP  
209 W. YAKIMA  
YAKIMA, WASH.

WEST VIRGINIA  
BECKLEY ICE & FEED  
BECKLEY, W. VA.

PAGODA SHP TR  
1114 HARPER  
BECKLEY, W. VA.

FOUNT HBY CTR.  
202 W. PIKE  
CHARLESTON, W. VA.

R. LANG HBY HSE  
908 WALNUT  
CHARLESTON, W. VA.

THE FOUNT HBY  
200 WASH  
CHARLESTON, W. VA.

JERRY'S AUTO SUP.  
310 W. PIKE  
CLARKSBURG, W. VA.

D. J. METZ  
1322 FAIRMONT  
FAIRMONT, W. VA.

HINTON HDWE  
933 S. 8th  
HINTON, W. VA.

PHILLIPS TRNS & HBYS  
422 MARKET  
HUNTINGTON, W. VA.

WESTERN AUTO  
149 N. QUEER  
MARTINSBURG, W. VA.

JERRY'S AUTO SUP.  
160 ROSASANT  
MORGANTOWN, W. VA.

MORGAN LEATHER  
341 SPRUCE  
MORGANTOWN, W. VA.

REED J. TANNER  
1100 LOUISE  
MORGANTOWN, W. VA.

WILSON HBY SHOP  
422 MARKET  
PARKERSBURG, W. VA.

NECKS HBY SHOP  
803 LEE  
SUMMERSBURG, W. VA.

DUNNS  
1065 MAIN  
WHEELING, W. VA.

S & R CORP.  
1156 MAIN  
WHEELING, W. VA.

WHITESVILLE DRUG  
WHITESVILLE, W. VA.

WISCONSIN  
LAPPEN BICYCLE  
222 E. WISC.  
APPLETON, WIS.

SCHIEDERMAGERS  
623-25 W. COLLEGE  
APPLETON, WIS.

MACS HBY SHOP  
228 S. SRING  
BEAVER DAM, WIS.

REED LYNN PAINT  
942 W. CENTER  
BELOIT, WIS.

PRINTZ FIRESTONE  
1315 W. CHESTNUT  
BURLINGTON, WIS.

TRP FISH PET HBY  
258 N. WASH.  
CEDARSBURG, WIS.

HEITINGERS  
MDL GRV PK & SHP  
ELM GROVE, WIS.

FRIESS HBY STUDIO  
47 N. MAIN  
FOND DU LAC, WIS.

BAY CRAFT & HBY  
517 FOREST  
GREEN BAY, WIS.

ELECTRIC TRAIN  
103 BROADWAY  
GREEN BAY, WIS.

TOMS HBY SHOP  
5637 BROAD  
GREENDALE, WIS.

KROETENS SPT HBY  
128 N. MAIN  
HARTFORD, WIS.

BROWNS HBY & TOY  
815 W. COURT  
JANESVILLE, WIS.

JIMS HBY CTR  
6122 22nd AVE.  
KENOSHA, WIS.

KRESSELS  
5709 7th AVE.  
KENOSHA, WIS.

FALLS HBY & SPT  
553 WESTERN  
SHEBOYAN FLs, WIS.

DRIGGETTS CYCLE  
3964 N. OAKLAND AVE.  
SHOREWOOD 11, WIS.

TOY CORNER  
202 N. MAIN ST.  
KIMBERLY, WIS.

A & W HBY CTR  
1005 LA CROSSE ST.  
LA CROSSE, WIS.

H & N HDWE  
1398 WILLIAMSON  
MADISON, WIS.

J & C HBY SHOP  
2094 ATKINS  
MADISON, WIS.

THE TOY SHOP  
933 S. 8th  
MANITOWOC, WIS.

SIEGERS SPT & HBY  
W. MAIN 4 COR.  
MENOMONEE FLs, WIS.

RALPHS TV & HBY  
2625 E. MAIN  
MERRILL, WIS.

C. BENZ & SON  
320 E. SIL SPR  
MILWAUKEE, WIS.

CAPITOL COURT  
5500 W. CAPITOL  
MILWAUKEE 16, WIS.

CASANOVAS  
1423 S. MUSKOG  
MILWAUKEE, WIS.

DRIGGETTS CYCLE  
3964 N. OAKLAND  
MILWAUKEE, WIS.

HOBBY HORSE  
CAPITOL COURT  
MILWAUKEE, WIS.



**AURORA PLASTICS CORP.**

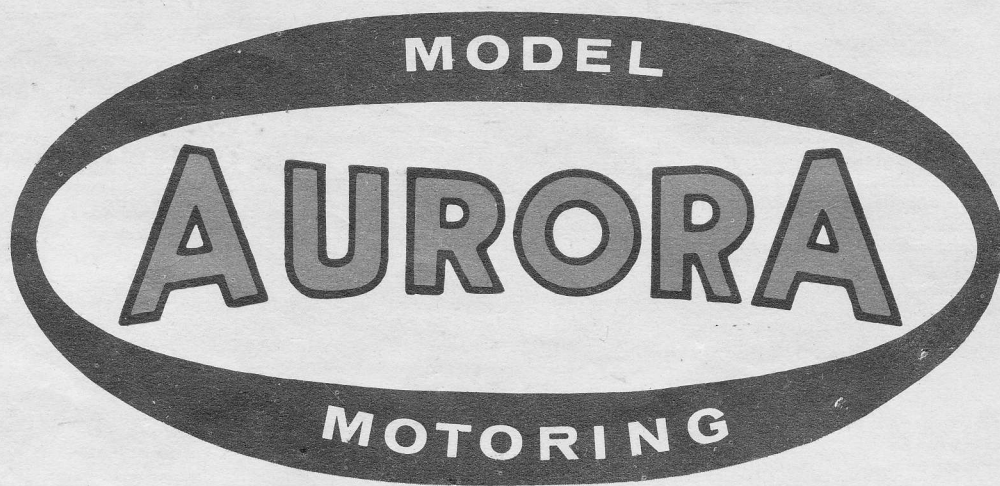

**DEPT. M.M. WEST HEMPSTEAD, N. Y.**

LITHO. IN U. S. A.

MADE IN U. S. A.